



ARIA X INSTALLATION INSTRUCTIONS



▪ INCLUDED

Box Contents

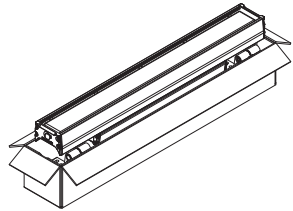

- Luminaire
- Mounting Brackets (Integral)

+ Run Box

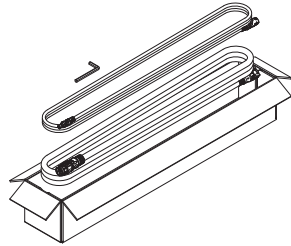

- Allen Key
- Cable Plastic Caps
- Cable Kits

⚠ ATTENTION

- Please observe / follow the instructions methodically.
- Please ensure the units are handled with extreme care.
- Do not remove product from packaging prematurely. Only remove from packaging when ready for installation.
- Failure to observe installation instructions and handling will void warranty of the product.
- Fittings must be installed by a licensed electrician.
- Before installing, make sure the power supply is switched off or mains cable is disconnected.
- Aria is designed for a wide range of applications, including those with low vibrations such as bridges and fixed metal structures. However, is not designed for heavy-duty environments with excessive vibration.

CONTENTS	LxWxH DIMENSIONS
Single Luminaire	582 x 191 x 121mm
Double Luminaire	637 x 249 x 151mm
Triple Luminaire	665 x 292 x 162.5mm
Run Box	Varies depending on quantity

▪ INSTALLATION LIMITS @ 230VAC

Maximum 40 x Single Luminaires per individual run.

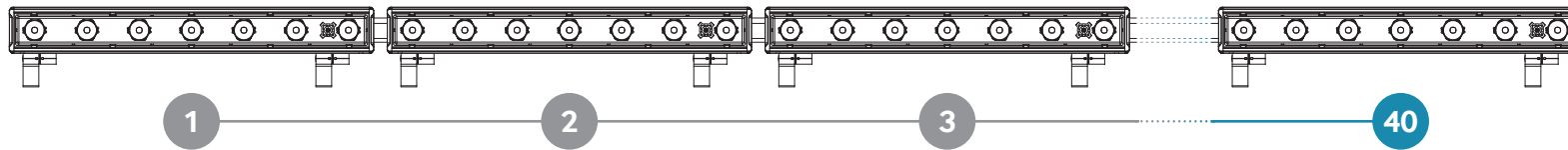

▪ INSTALLATION LIMITS @ 120VAC

Maximum 20 x Single Luminaires per individual run.

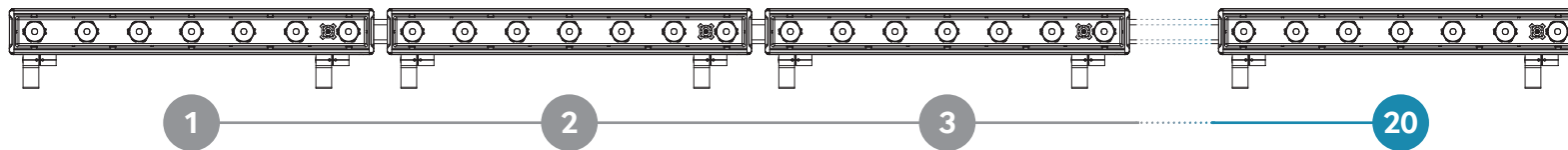

2mm distance between the ends of fittings to keep consistent LED pitch.

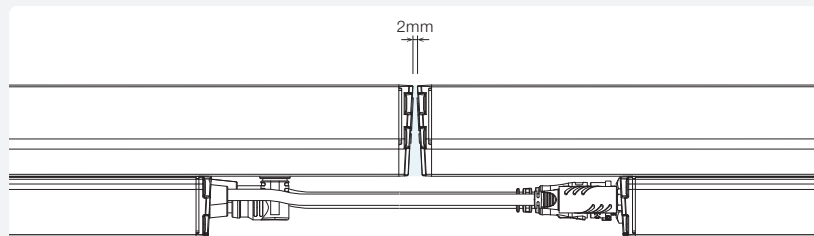

■ INSTALLATION LIMITS @ 230VAC

Maximum 20 x Double Luminaires fittings per individual run.

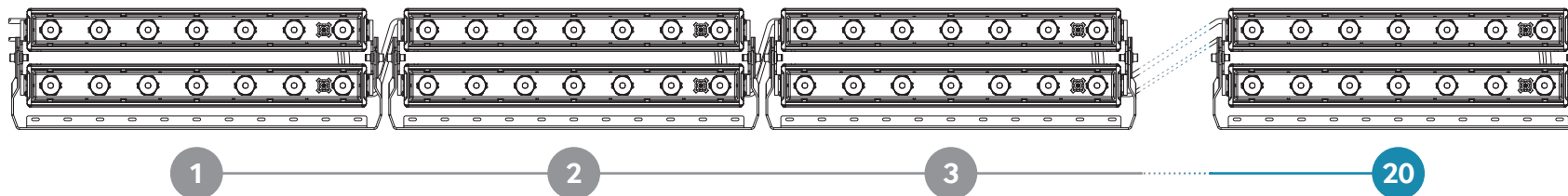

■ INSTALLATION LIMITS @ 120VAC

Maximum 10 x Double Luminaires per individual run.

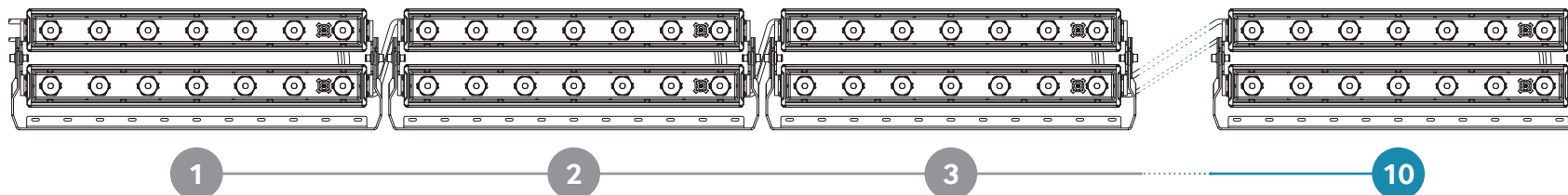

▪ INSTALLATION LIMITS @ 230VAC

Maximum 13 x Triple Luminaires per individual run.

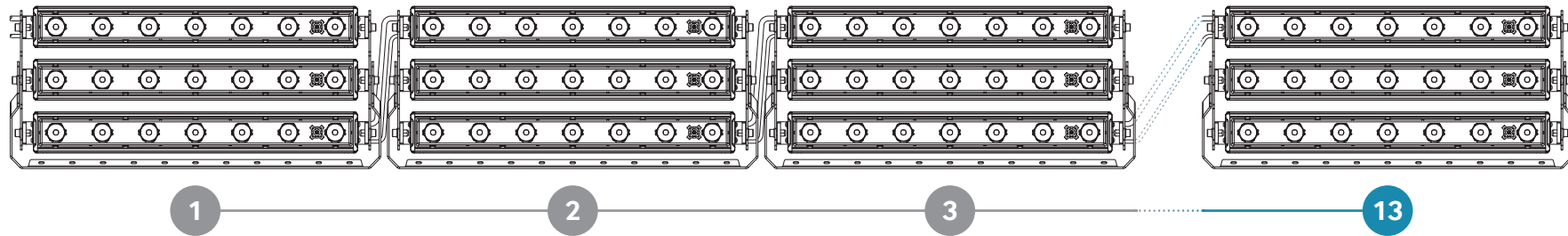

▪ INSTALLATION LIMITS @ 120VAC

Maximum 6 x Triple Luminaires per individual run.

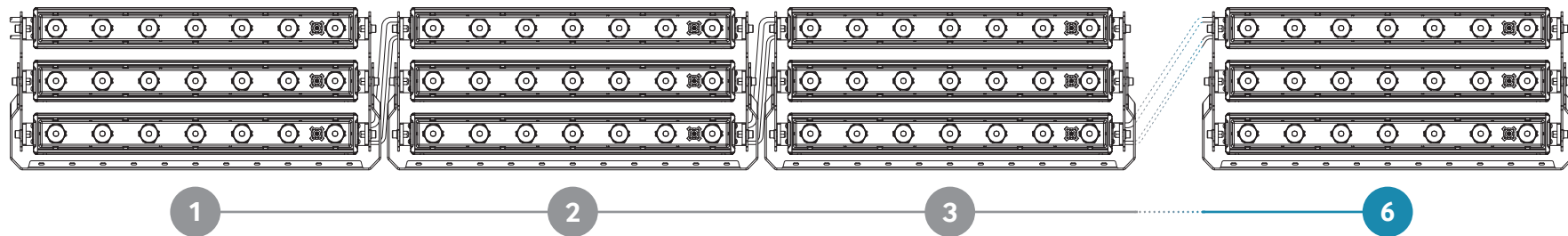

■ WIRING CONFIGURATION

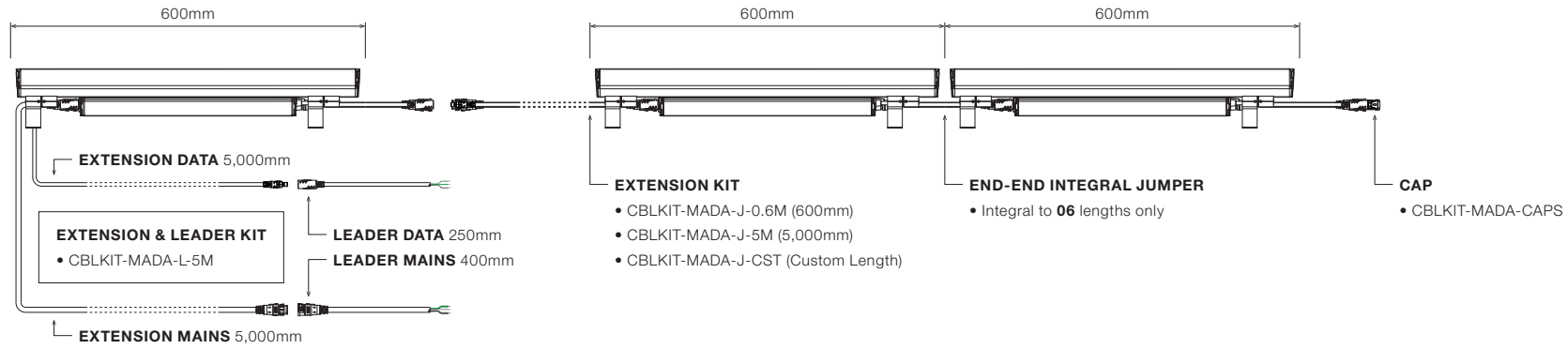

DATA Pinouts



MAINS Pinouts





WIRING DIAGRAMS

DALI INSTALLATION

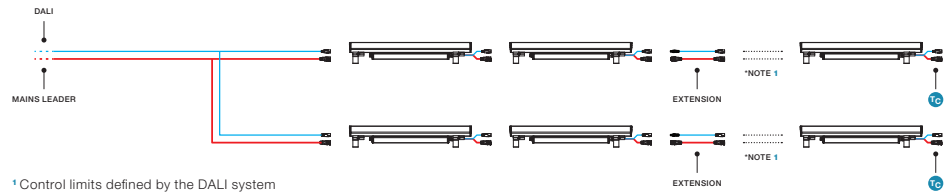

¹ Control limits defined by the DALI system

0-10V INSTALLATION

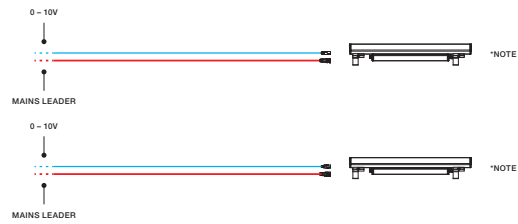

¹ Single luminaire control

CASAMBI INSTALLATION

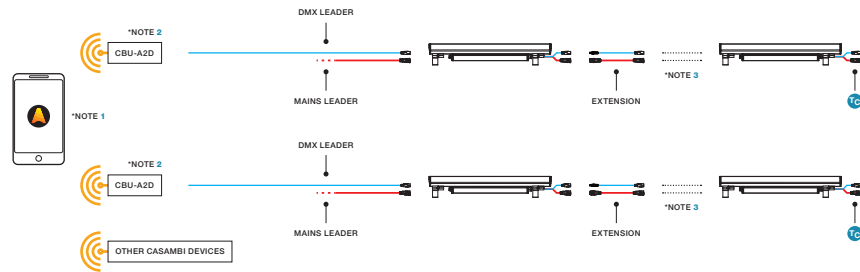

¹ Please refer to Casambi's documentation about system limits and range

² Please refer to CBU-A2D documentation for reference

³ Control limits defined by the DALI system



CONNECTION

Before installation begins, please ensure that you understand the fitting layout as per luminaire schedule.

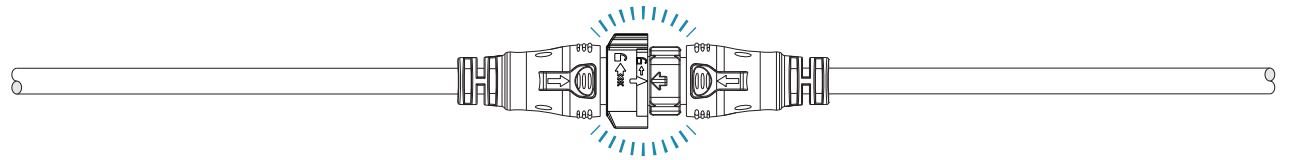
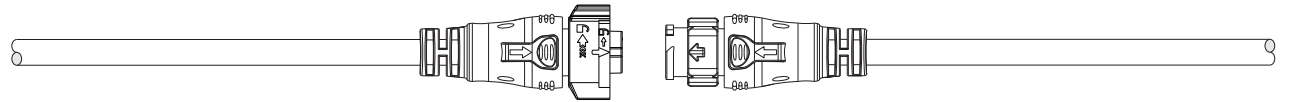
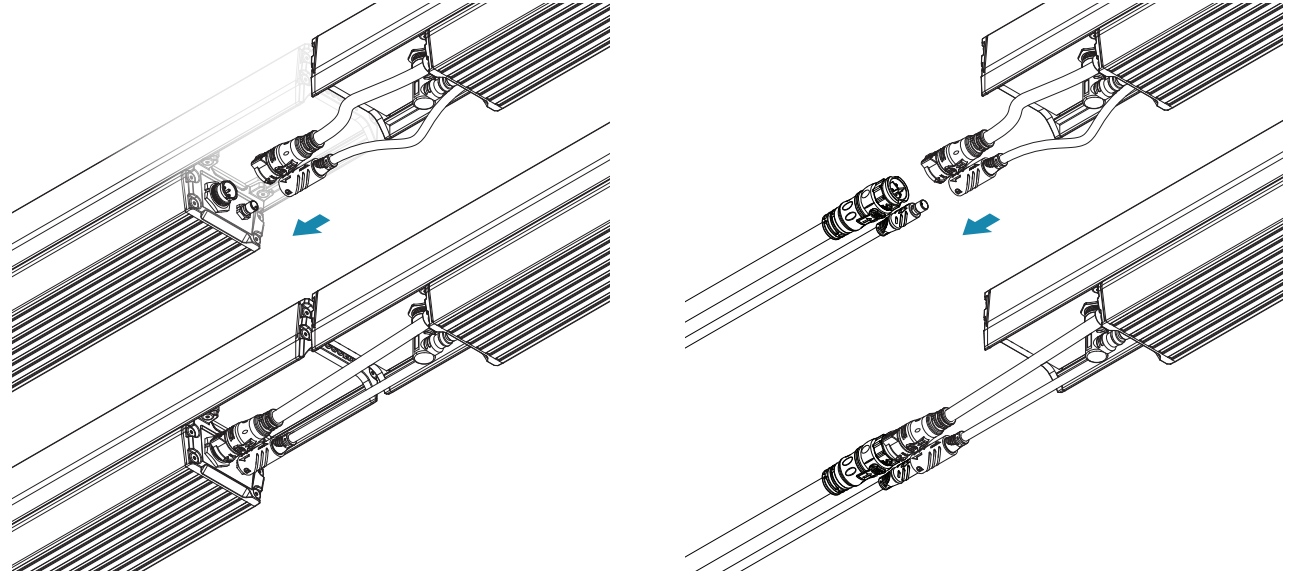

CLICK!



▪ DIMENSIONS

Single Luminaire

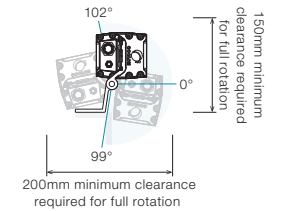
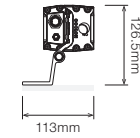
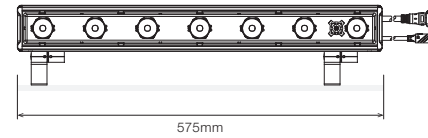

Double Luminaire

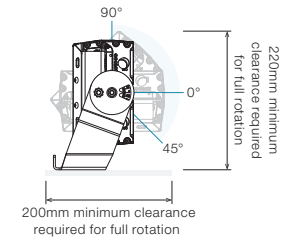
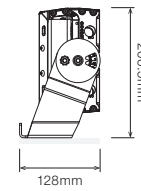
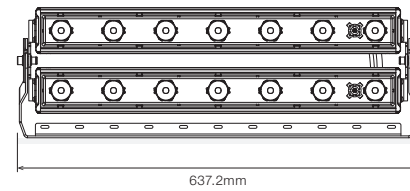

Triple Luminaire

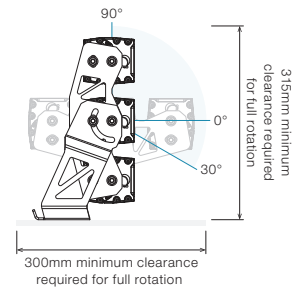
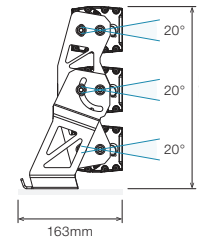
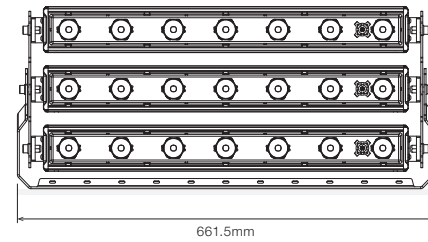



▪ DIMENSIONS WITH GLARE SHIELD

Single Luminaire

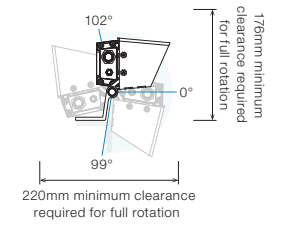
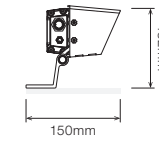
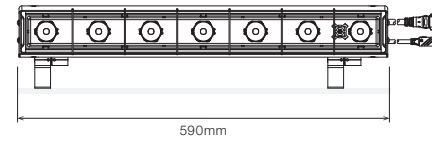

Double Luminaire

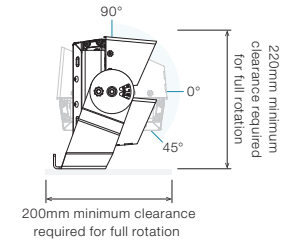
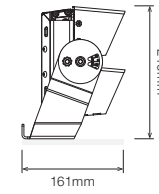
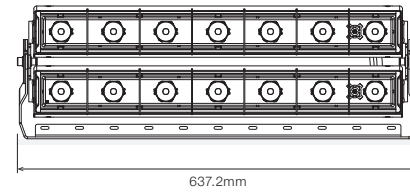

Triple Luminaire

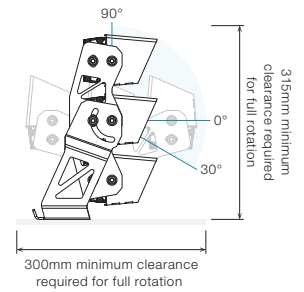
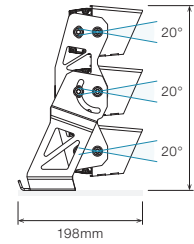
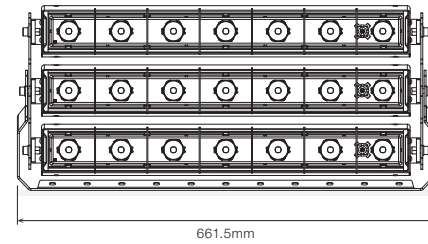

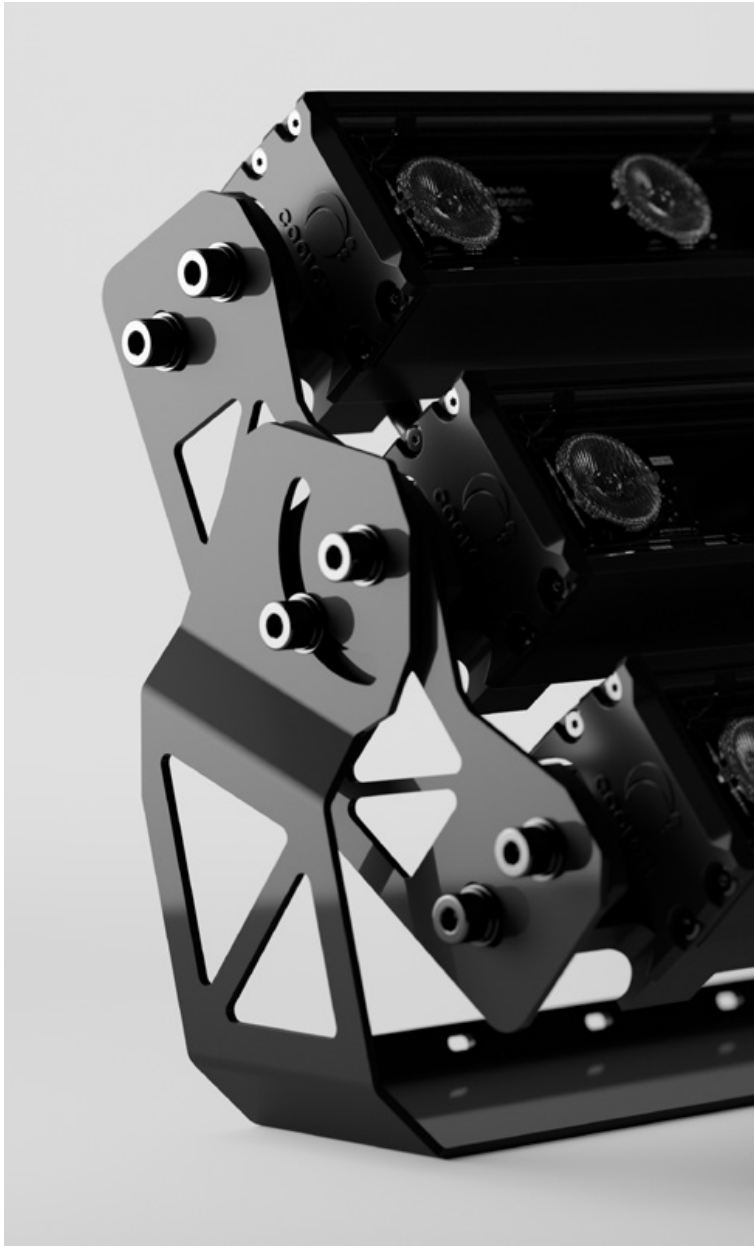

▪ MOUNTING FOOTPRINTS

Single Luminaire

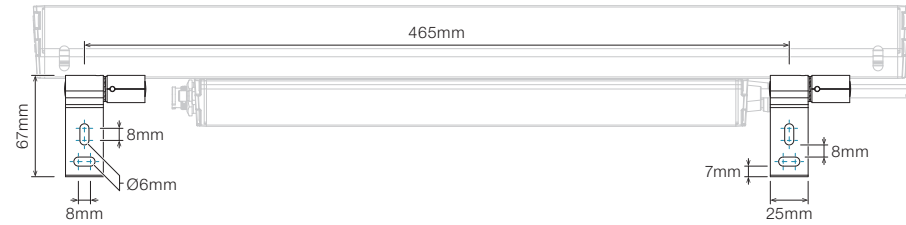

MINIMUM RECOMMENDED FASTENERS PER LUMINAIRE:
4 x M5 bolts for single luminaires

MOUNTING BRACKET MATERIAL:
Aluminium

APPLICATION:
Low vibration

Double Luminaire

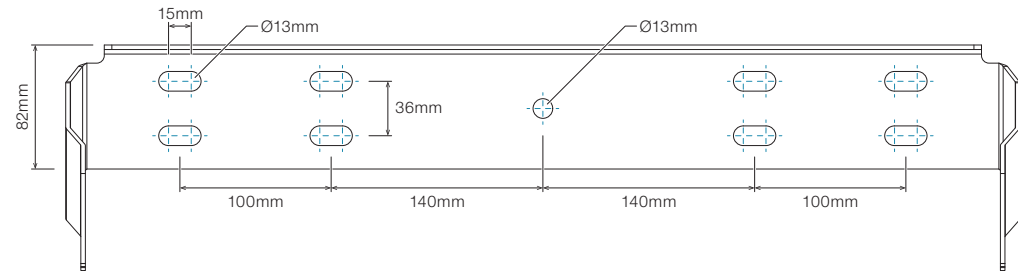

Triple Luminaire

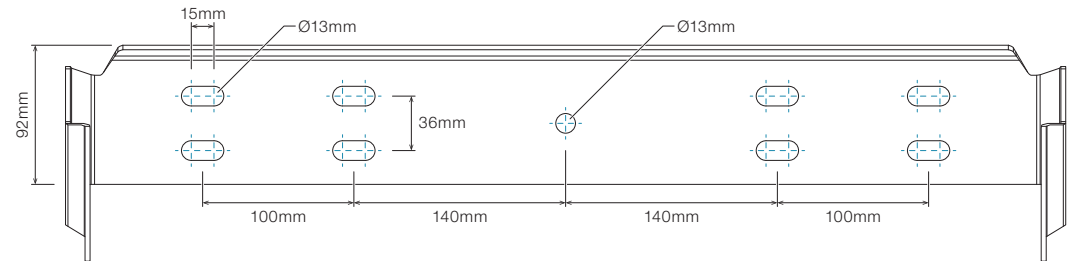

MINIMUM RECOMMENDED FASTENERS PER LUMINAIRE:
4 x M12 bolts for double and triple luminaires

MOUNTING BRACKET MATERIAL:
Stainless Steel 304

APPLICATION:
Low vibration

AIMING SINGLE LUMINAIRE

STEP 1

Loosen **Screws A** and **B** counter clockwise to allow for rotation of the luminaire.

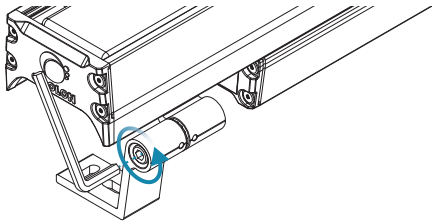

STEP 2

Rotate the luminaire to your desired angle.

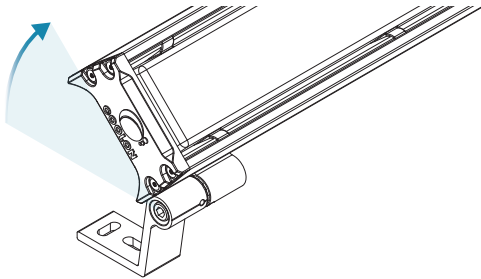

STEP 3

Tighten **Screws A** and **B** clockwise to lock into position (9Nm).

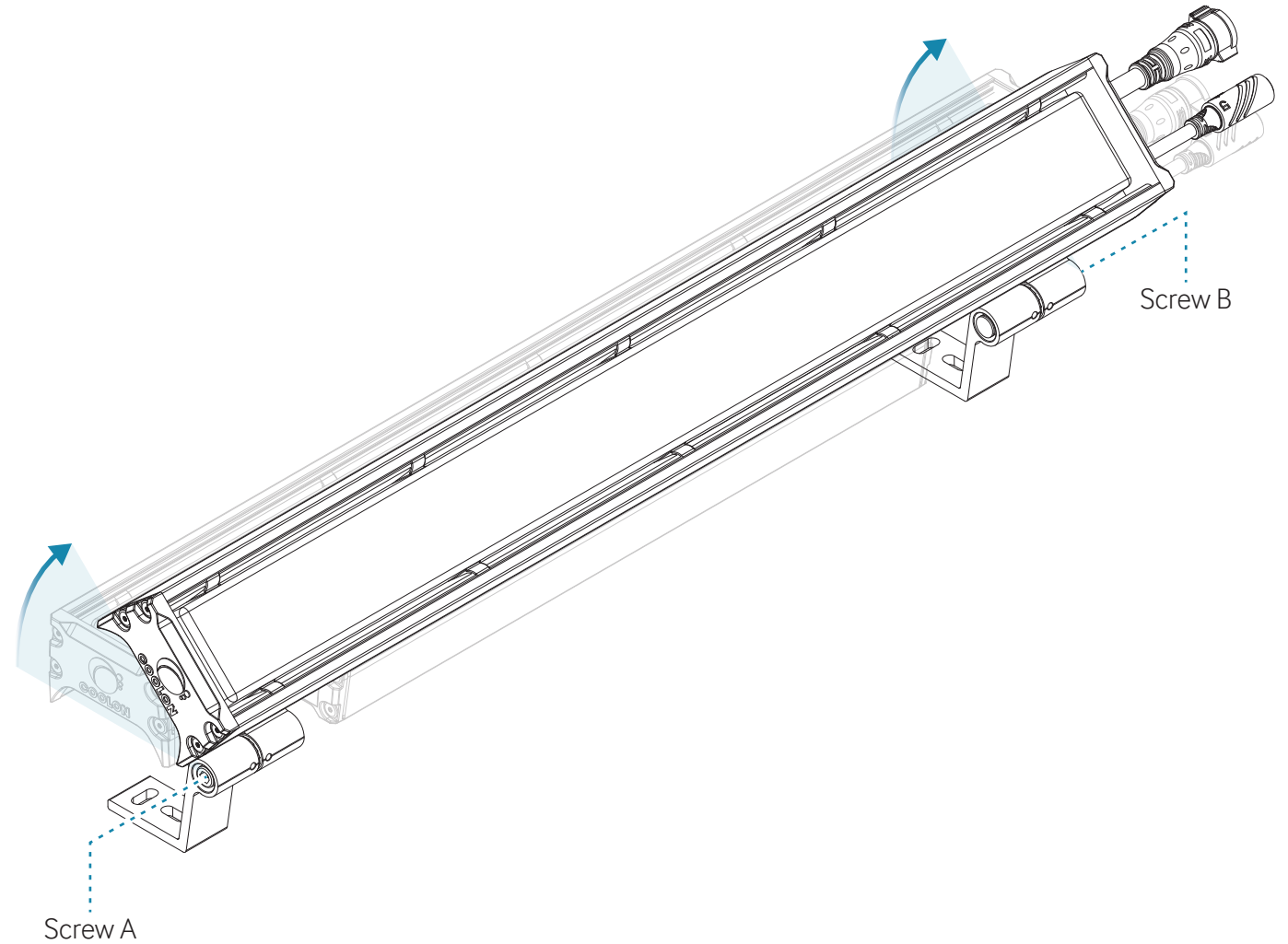
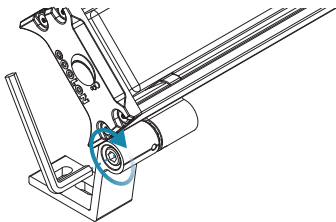

AIMING DOUBLE LUMINAIRE

▪ STEP 1

Loosen the angular adjustment M8 screws.

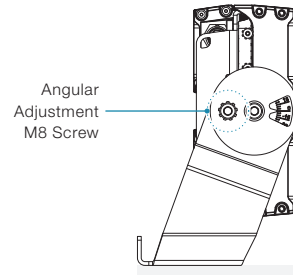

▪ STEP 2

Once luminaire is aimed, tighten to 7Nm. The bracket allows for 90° vertical rotation and 45° forwards rotation.

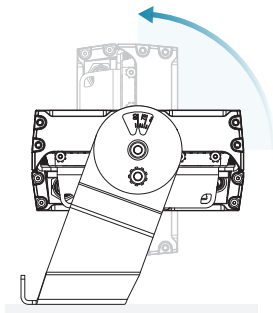

AIMING TRIPLE LUMINAIRE

▪ STEP 1

Loosen the angular adjustment M8 screws to adjust angle of the triple luminaire array.

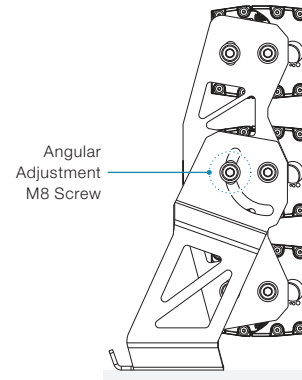

▪ STEP 2

Once luminaire is aimed, tighten to 7Nm. The bracket allows for 90° vertical rotation and 30° forwards rotation.

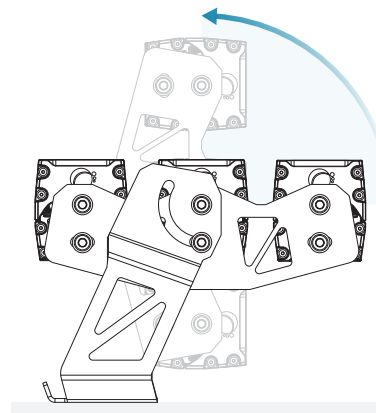

▪ STEP 3

This bracket also allows for individual angle adjust of each luminaire. Loosen each angular adjustment M8 screws.

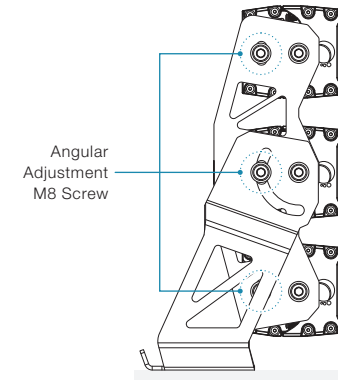

▪ STEP 4

Once luminaire is aimed, tighten to 7Nm. The bracket allows for 10° positive and negative rotation.

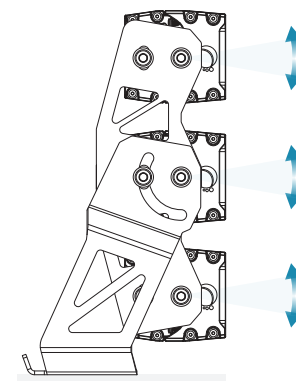

LUMINAIRE SAFETY LANYARD PROVISIONS

Utilize provisioned apertures if safety lanyards are required in the installation.

For maximum safety, utilize a safety lanyard for each provision including single fixtures within the double and triple arrays.

Single Luminaire

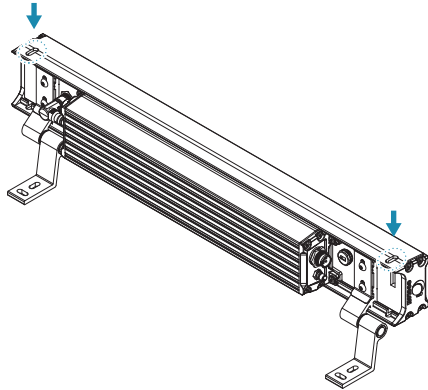

Double Luminaire

Utilize safety lanyard provisions for the bracket.

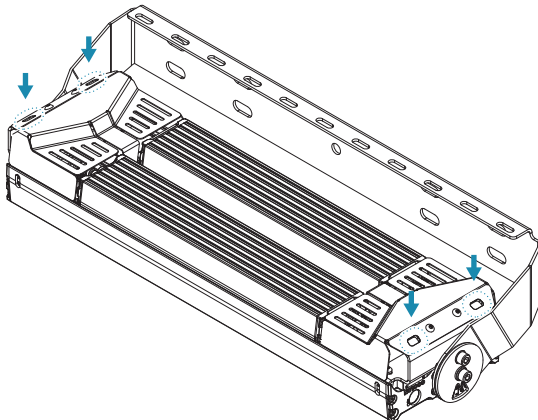

Triple Luminaire

Utilize safety lanyard provisions for the bracket.

