

A modern interior space featuring a curved ceiling with a mobile light fixture. The walls are covered in vertical wood panels with gold-colored trim. The lighting is warm and ambient.

 COOLON

ALTO CL

A P P L I C A T I O N G U I D E

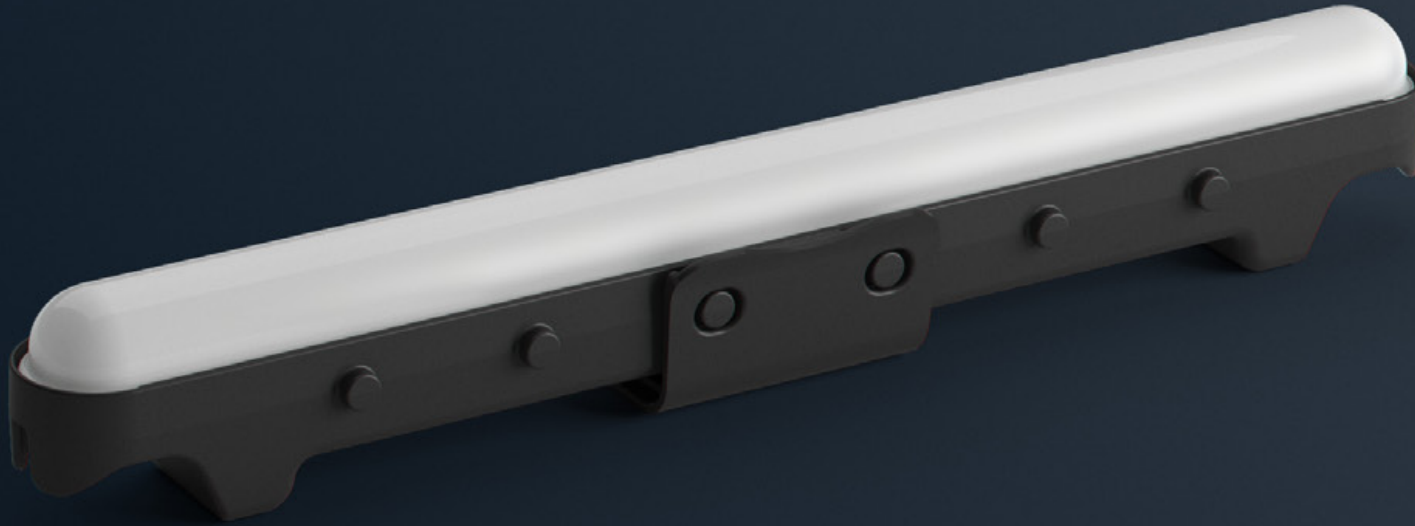

The following pages are guidelines / examples for various cove detail installations.
The design was conducted using Alto CL 10W / Metre and 15W / Metre in 3000K.

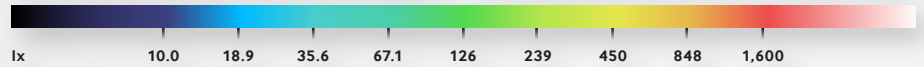
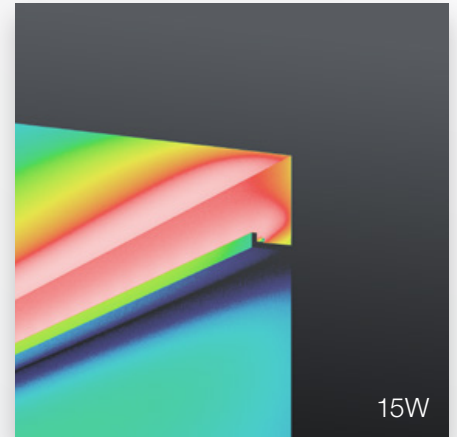
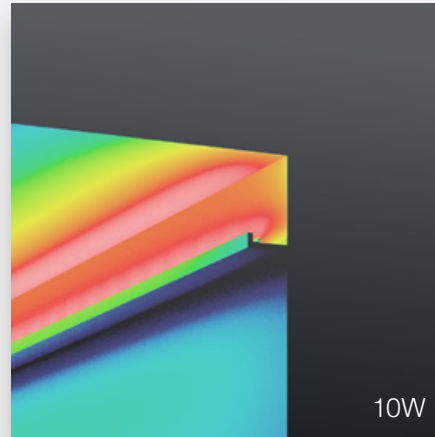
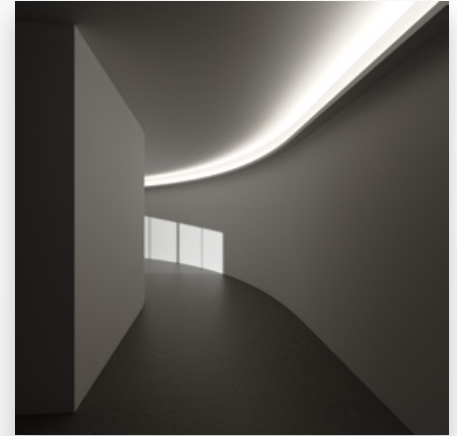
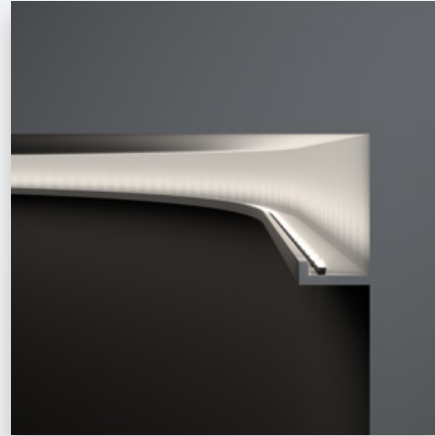
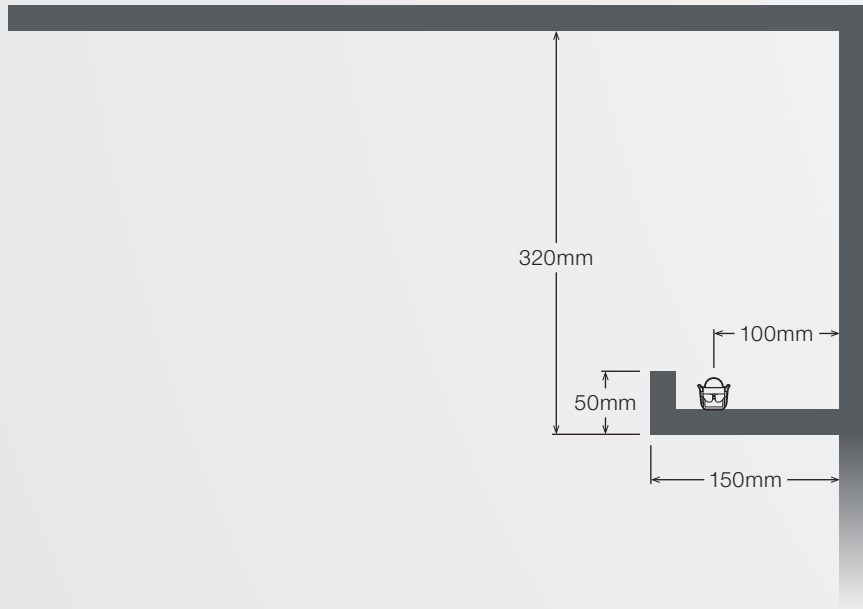

Cove A

Alto CL, 3000K

ALTO CL APPLICATION GUIDE

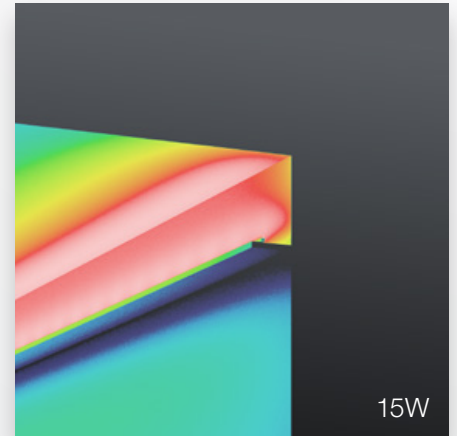
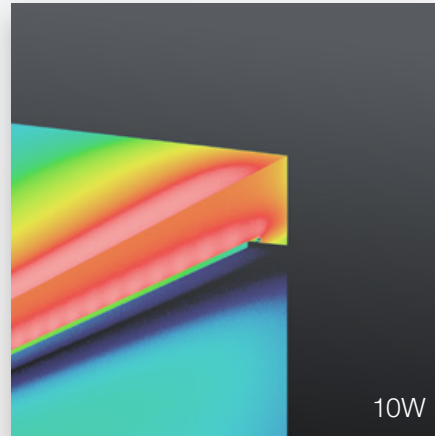
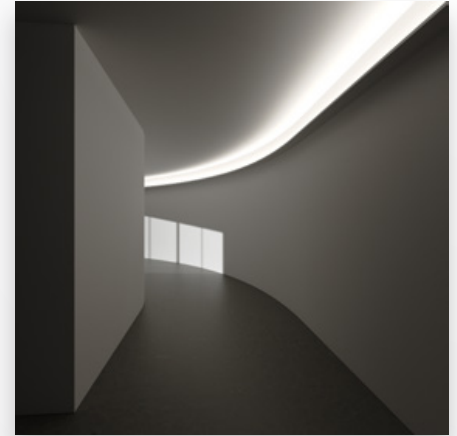
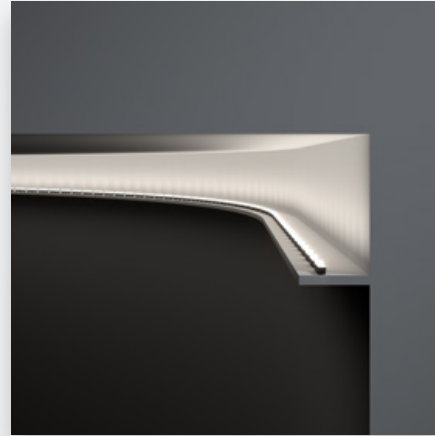
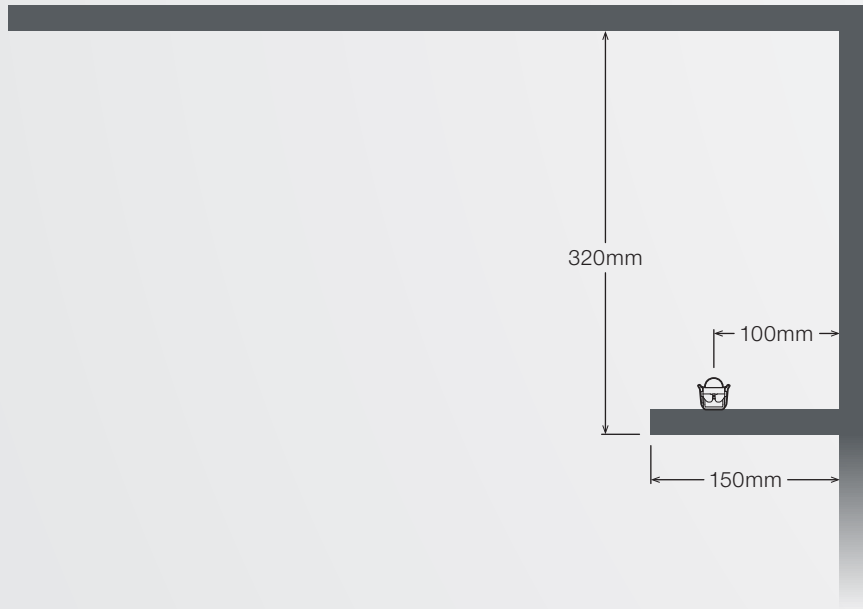

Cove B

Alto CL, 3000K

ALTO CL APPLICATION GUIDE

*Product may be visible at certain angles and mounting heights.

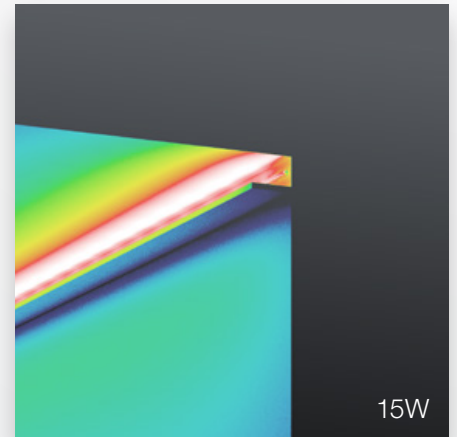
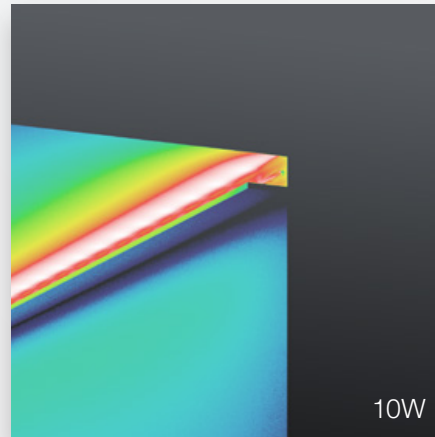
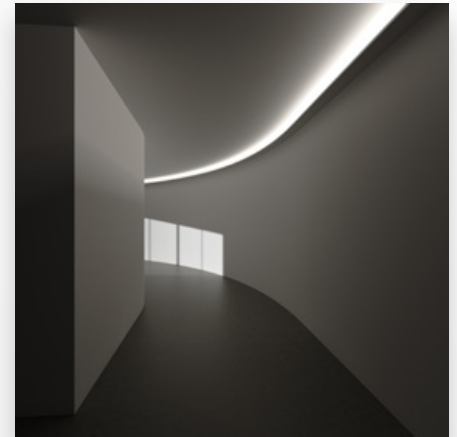
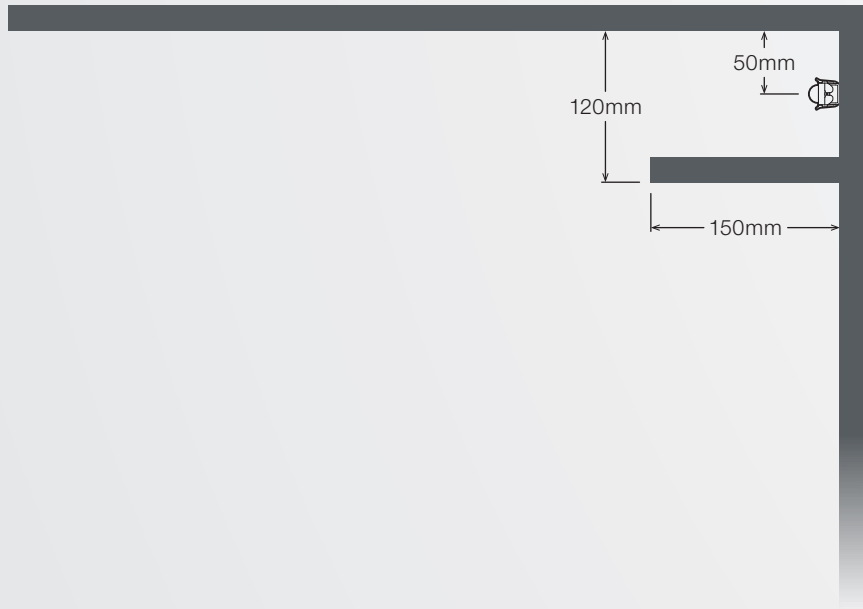

Cove C

Alto CL, 3000K

ALTO CL APPLICATION GUIDE

*Product may be visible at certain angles and mounting heights.

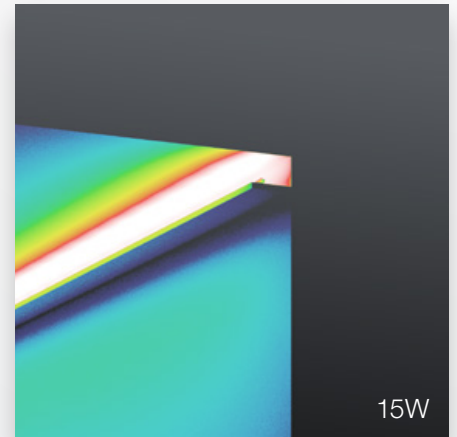
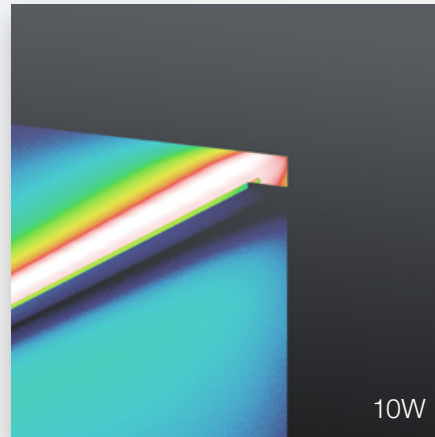
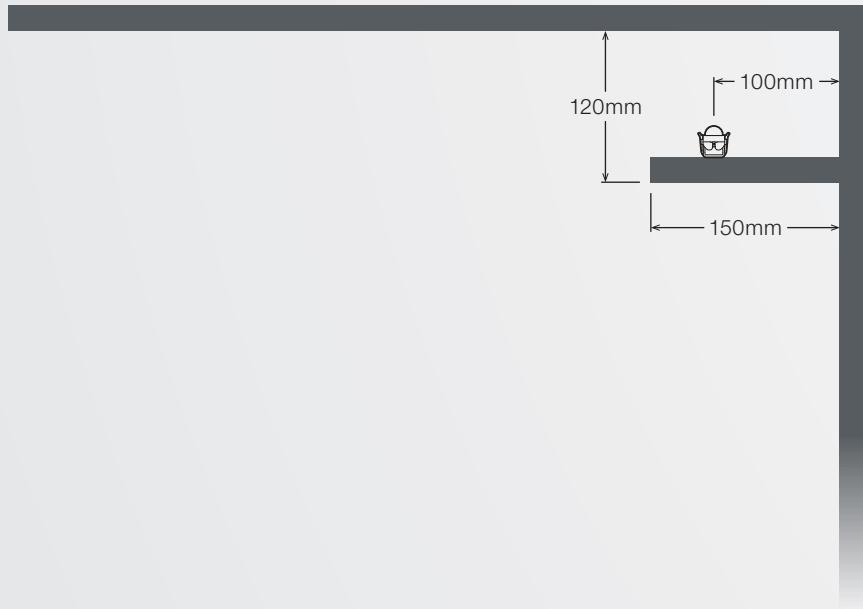

Cove D

Alto CL, 3000K

ALTO CL APPLICATION GUIDE

*Product may be visible at certain angles and mounting heights.

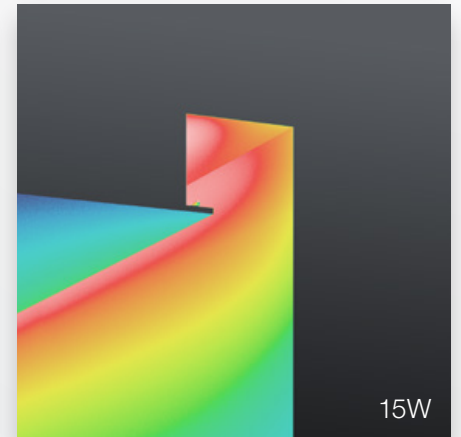
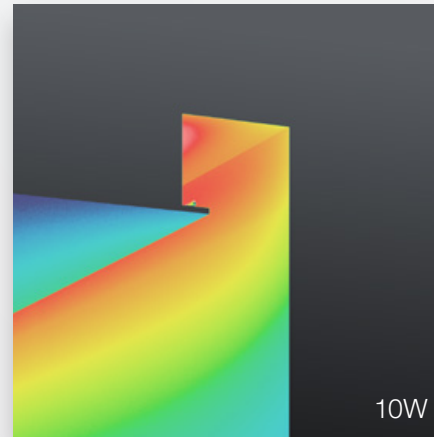
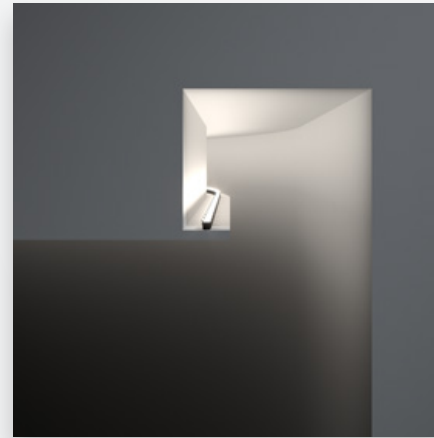
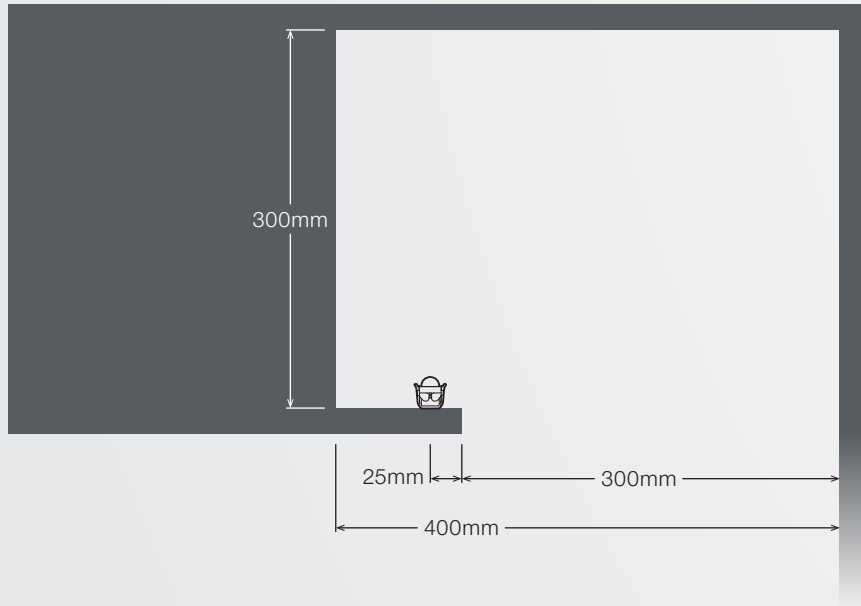

Cove E

Alto CL, 3000K

ALTO CL APPLICATION GUIDE

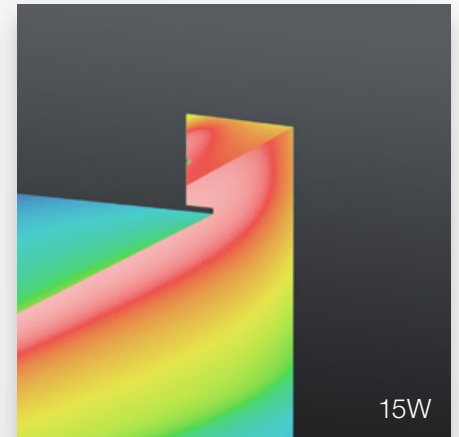
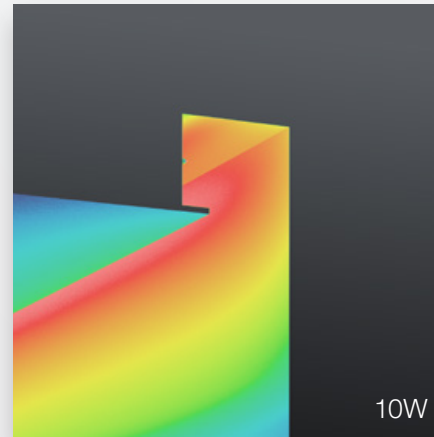
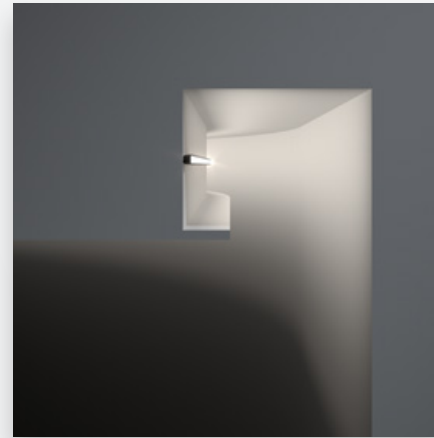
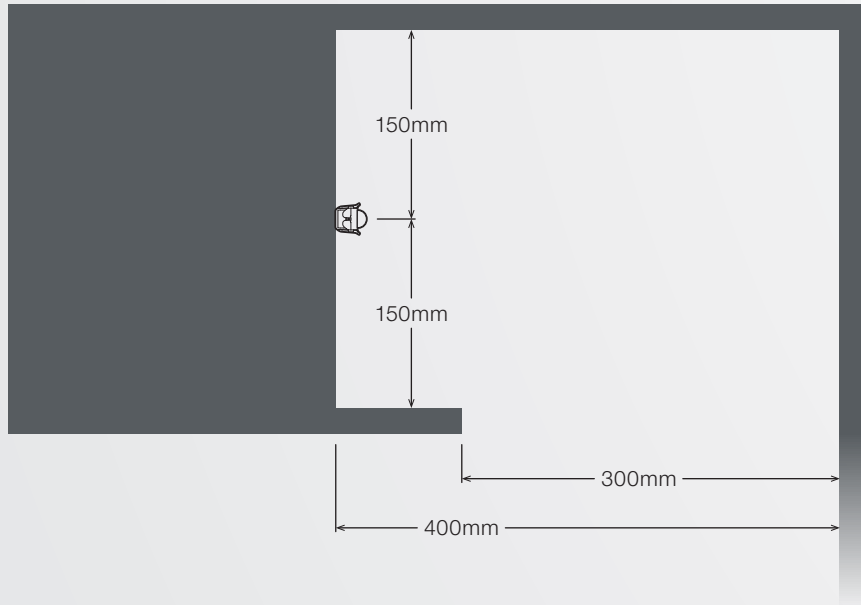

Cove F

Alto CL, 3000K

ALTO CL APPLICATION GUIDE

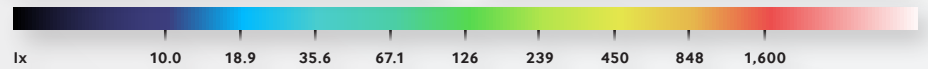
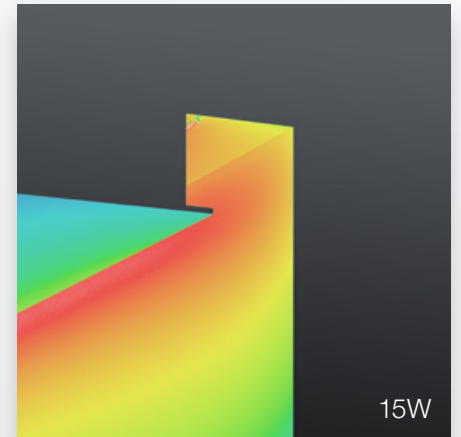
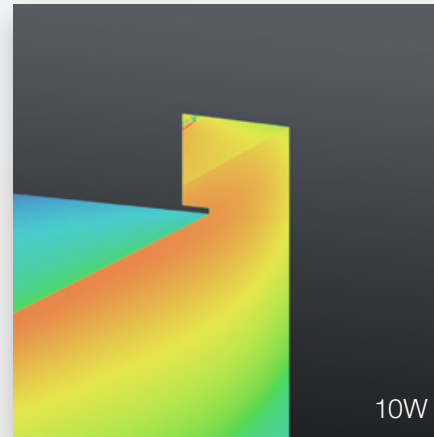
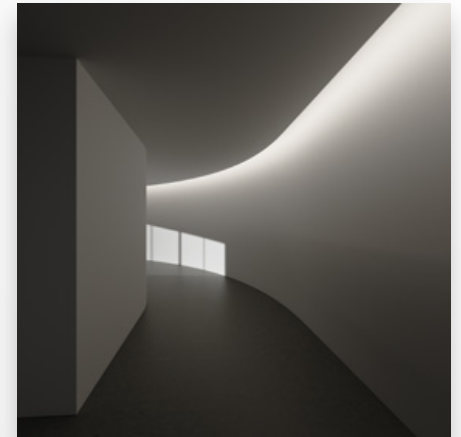
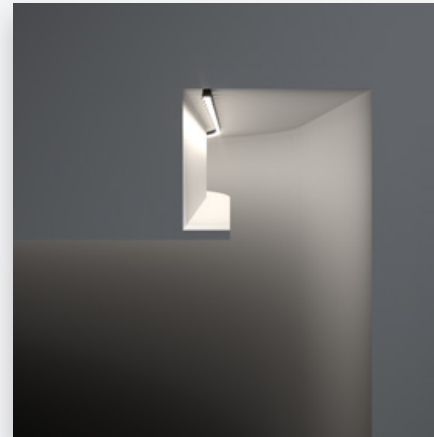
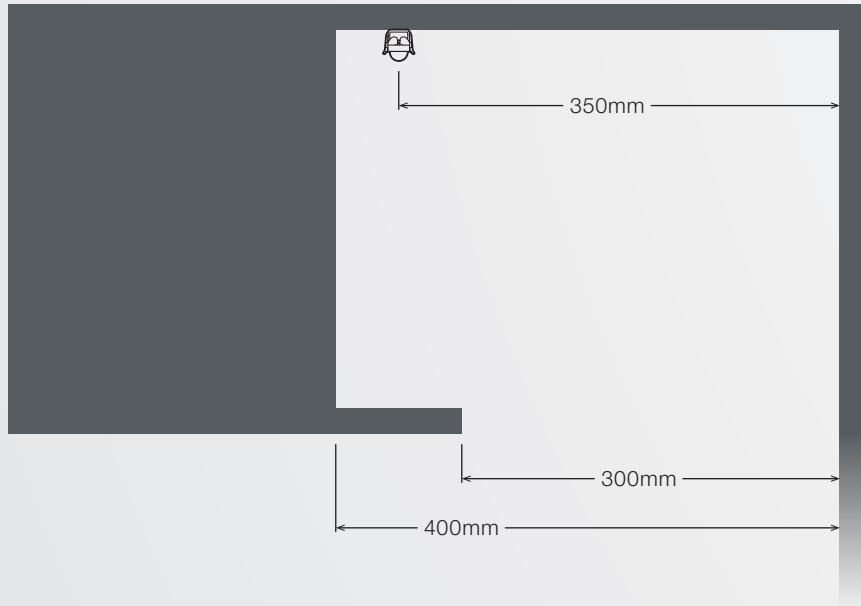

Cove G

Alto CL, 3000K

ALTO CL APPLICATION GUIDE

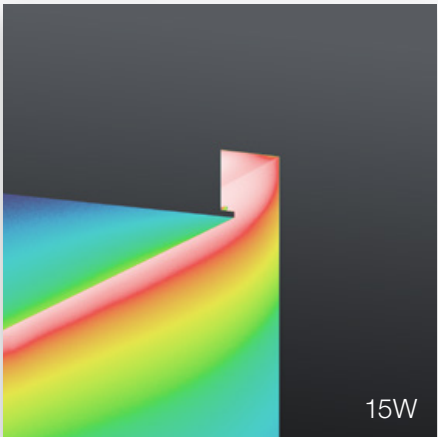
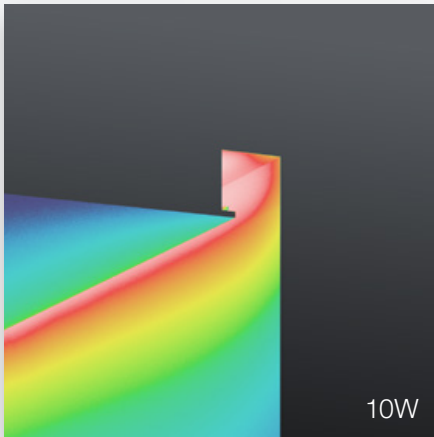
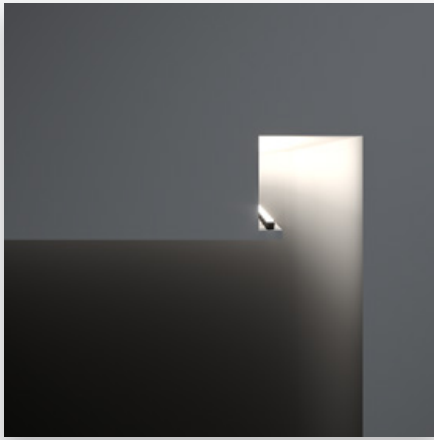
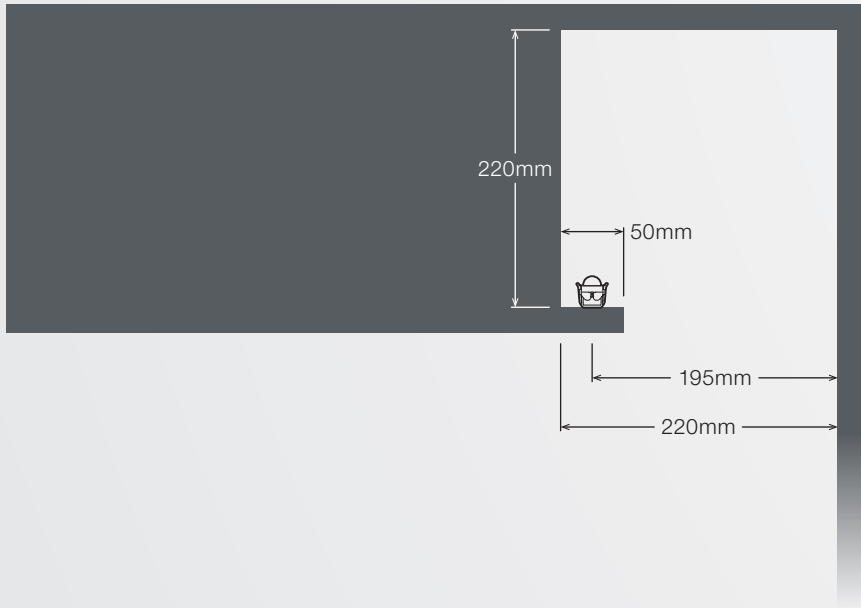

Cove H

Alto CL, 3000K

ALTO CL APPLICATION GUIDE

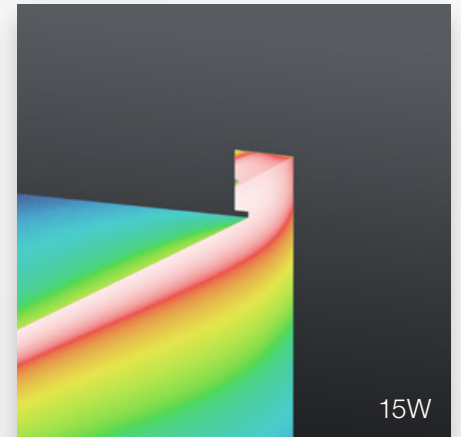
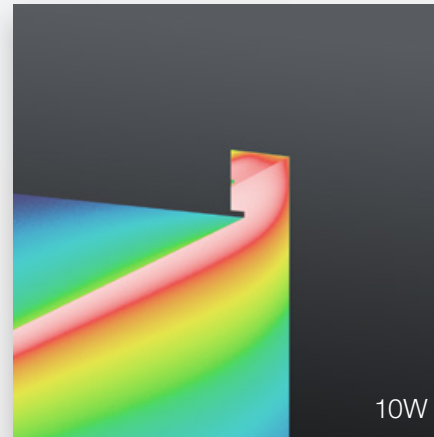
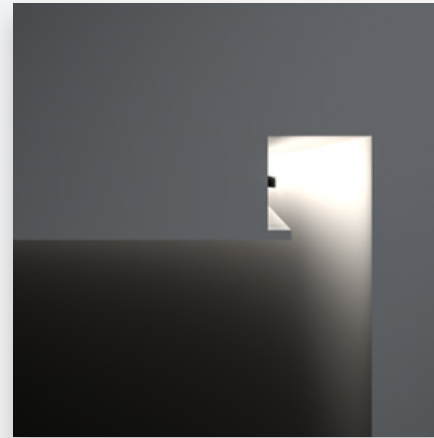
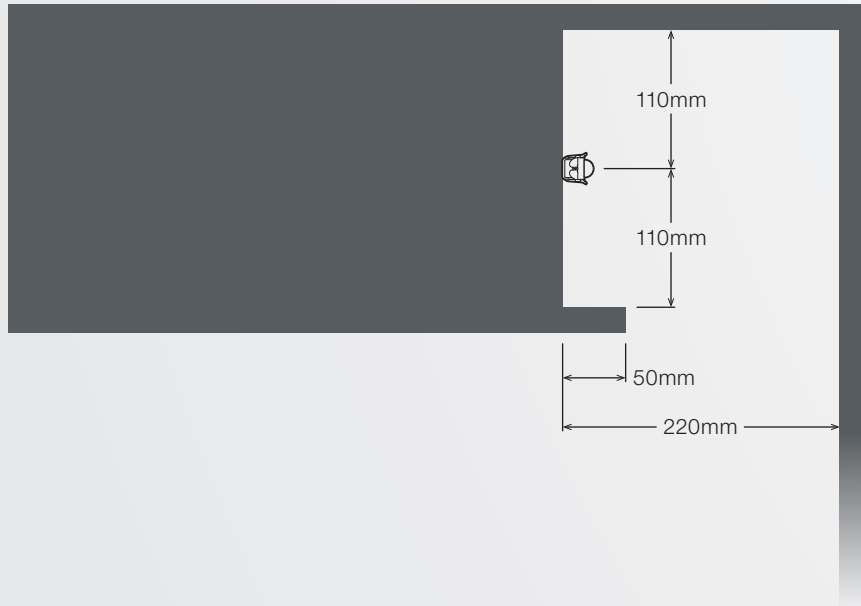

Cove I

Alto CL, 3000K

ALTO CL APPLICATION GUIDE

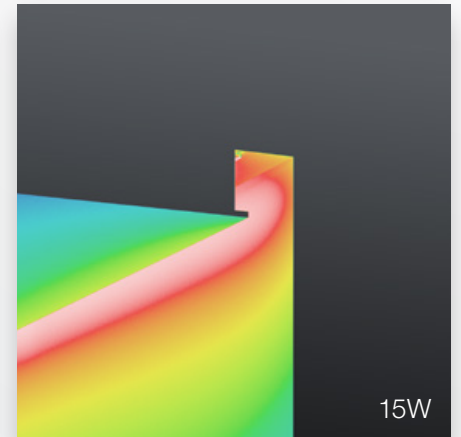
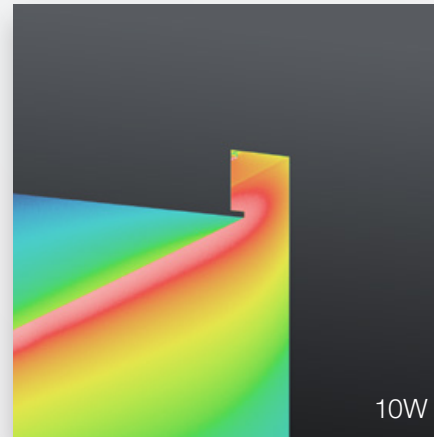
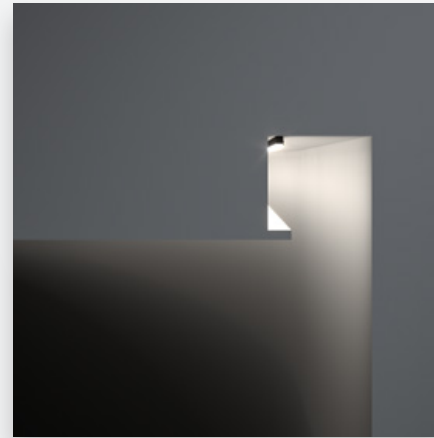
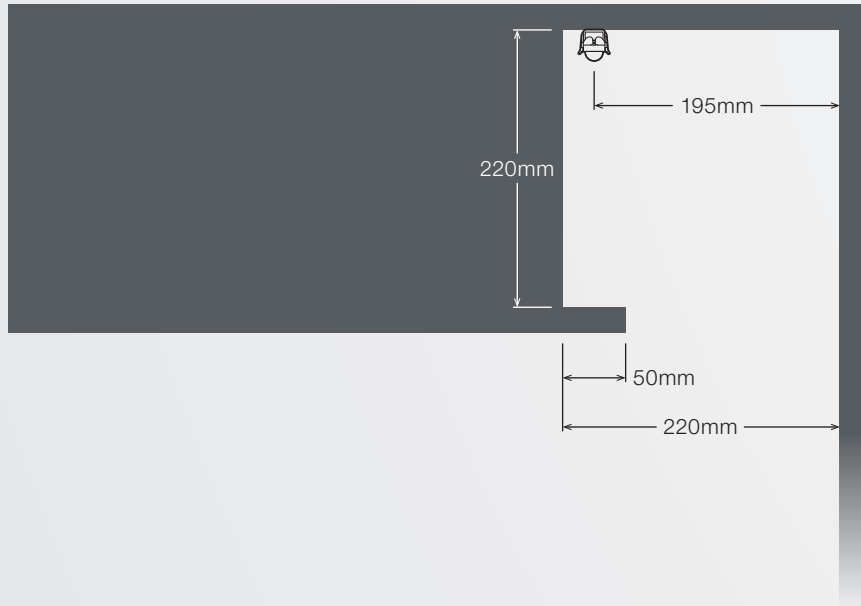

Cove J

Alto CL, 3000K

ALTO CL APPLICATION GUIDE

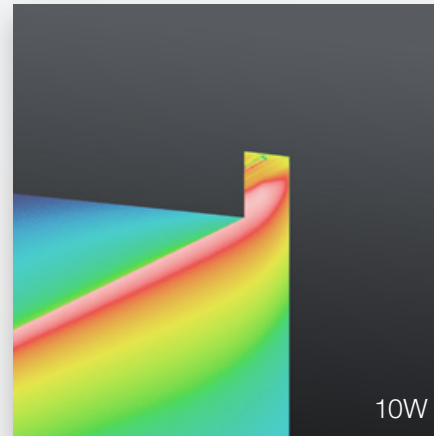
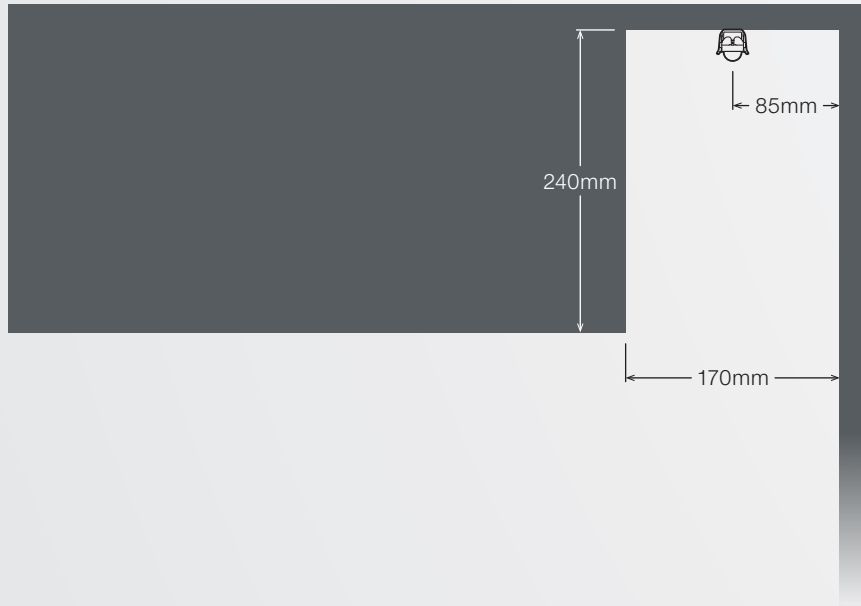

10W

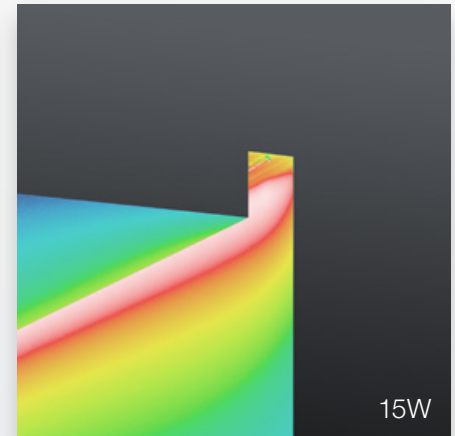

15W



Cove K

Alto CL, 3000K

ALTO CL APPLICATION GUIDE

*Product may be visible at certain angles and mounting heights.

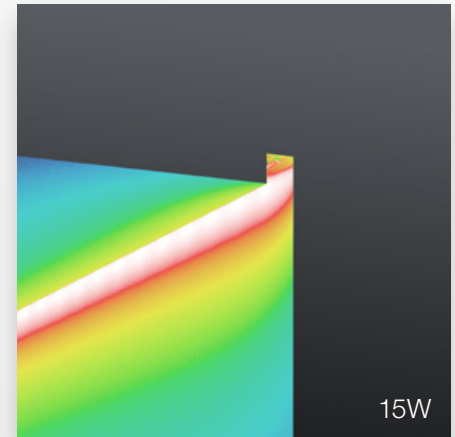
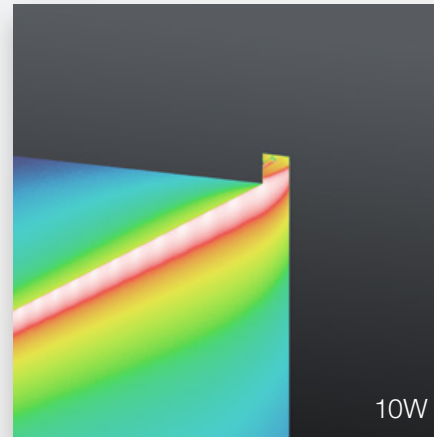
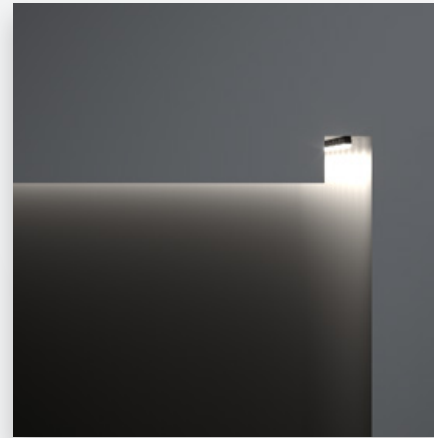
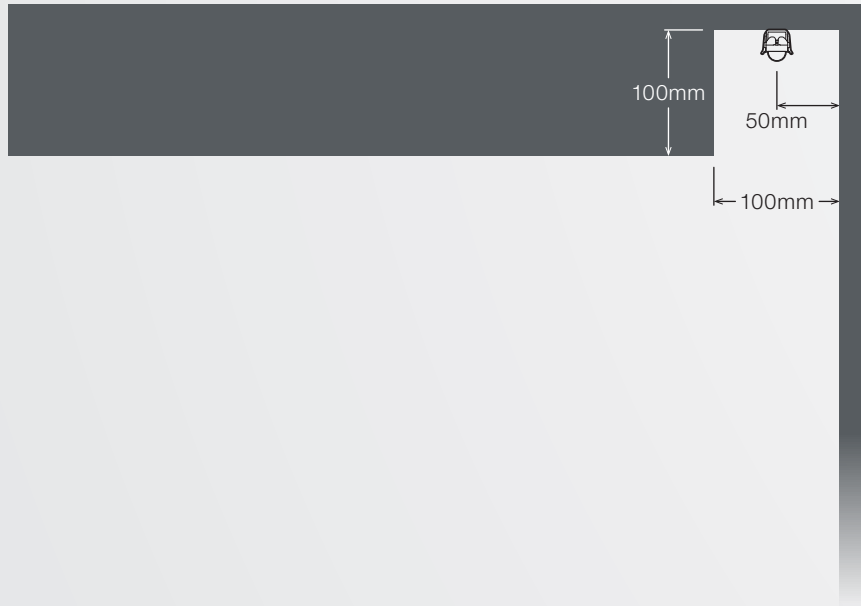

Cove L

Alto CL, 3000K

ALTO CL APPLICATION GUIDE

*Product may be visible at certain angles and mounting heights.

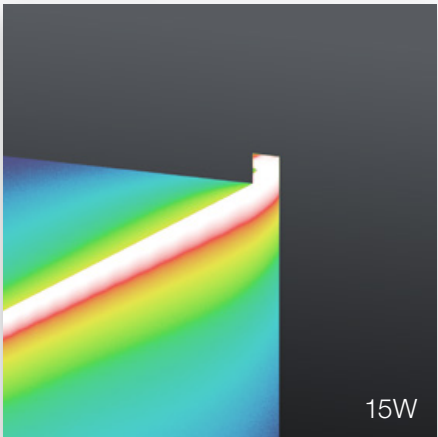
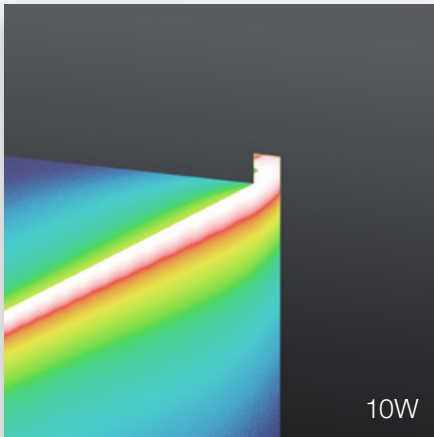
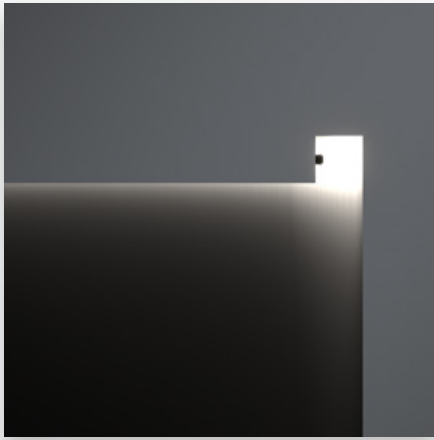

Cove M

Alto CL, 3000K

ALTO CL APPLICATION GUIDE

*Product may be visible at certain angles and mounting heights.

CL Module placement along a curve

Ideal Module Placement

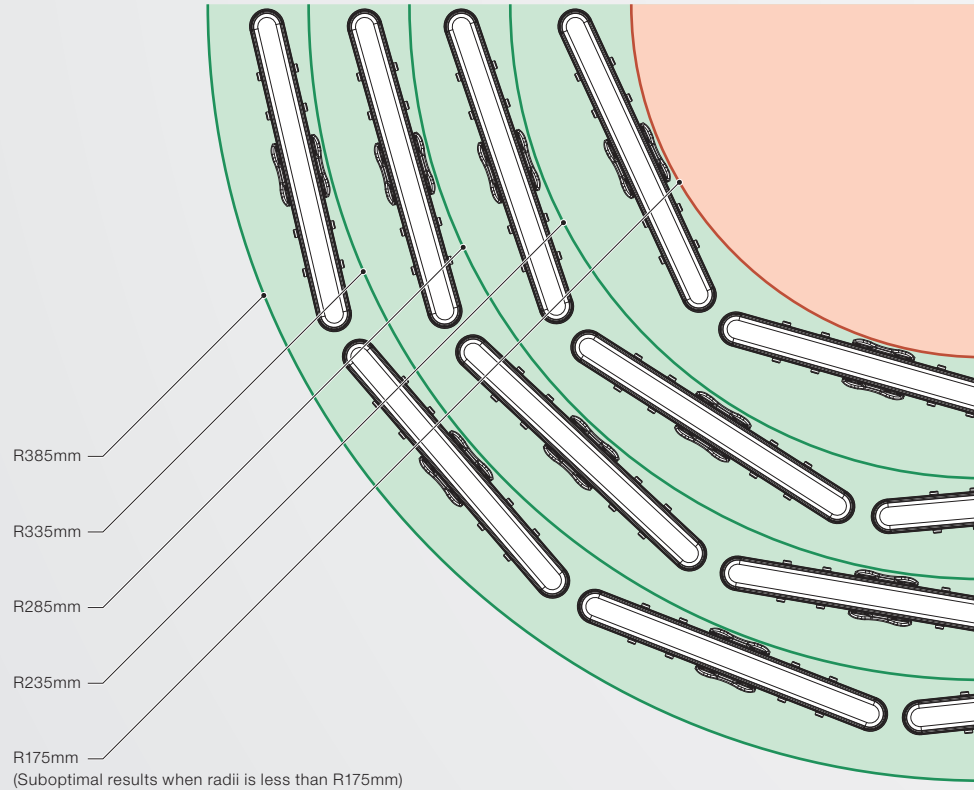

Distance from Wall

Minimum 50mm distance from illuminated walls.

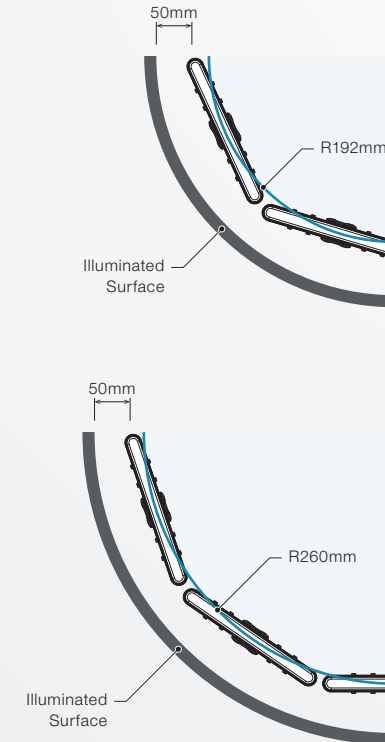

PROJECT

Focus Apartments



Lighting Partner	Buckford Illumination Group
Electrical Engineer	Stantec
Electrical Contractor	Appselec
Photography	Central Equity

PROJECT

ING Wyong Sydney

Lighting Partner	Jadecross
Lighting Design	Aston Consulting
Design	WMH Architects
Photography	Tyrone Branigan



PROJECT

Okta Sydney



Lighting Partner	Jadecross
Lighting Design	Aston Consulting
Project Manager	Facilitate
Architect	M Moser Associates
Photography	Terence Chin Photography

PROJECT

Wrest Point



Lighting Partner Southern Lighting & Distribution

Lighting Design Wood & Grieve Engineers

Photography Natalie Mendham Photography

PROJECT

Park Hyatt Hotel



Client	Park Hyatt Melbourne
Lighting Design	Electrolight Melbourne
Photography	Hygge Photography

DOWNLOADS

 Datasheet



 Installation Manual



 Brochure



EXPLORE PROJECTS FEATURING THE ALTO CL

 Gallery



Please contact
Coolon LED Lighting
to locate your nearest partner



12 – 14 Austral Place, Hallam VIC 3803, Australia

PHONE

1300 287 533
+613 8681 3633

EMAIL

archsales@coolon.com.au

WEBSITE

www.coolon.com.au

24.07

All documentation is subject to change without notice. Refer to our website for the latest information.



JOIN US



Search: Coolon LED Lighting