

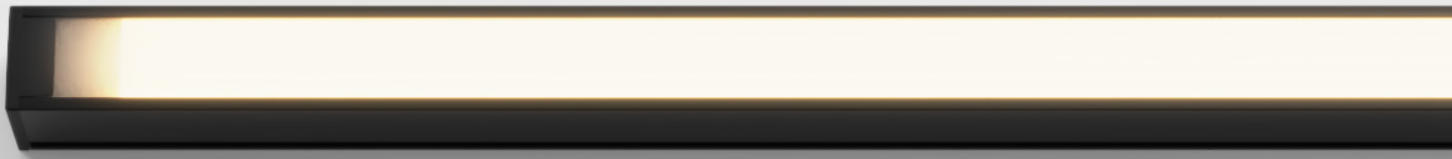

# MULTO IP

LED STRIP STR-MULTO IP





Multo IP is a highly customisable exterior strip with a wide range of colour temperature, length and profile options to select from.

Available in two wattages (9W or 16W), the Multo IP range offers a completely uniform glowing diffuser where no dots or scalloping is visible along the length of the luminaire or the illuminated surface.

**POWER**

**9W**

9.6W / metre



**P20T**

**16W**

16W / metre



**P20T**

**COLOUR TEMPERATURE**

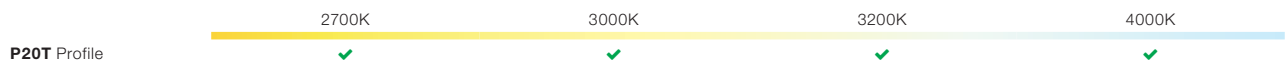

# UNIFORM GLOW

The diffuser height and the pitch of the LED has been precisely designed to ensure perfectly uniform illumination along the length of the diffuser.



# ELEGANT ENCAPSULATION

Multo IP utilises Coolon's encapsulation or gel-fill technology to deliver a truly extraordinary outdoor luminaire. IP66, IK08, shock and abrasion resistance, thermal protection, and dashing good looks, all in one.

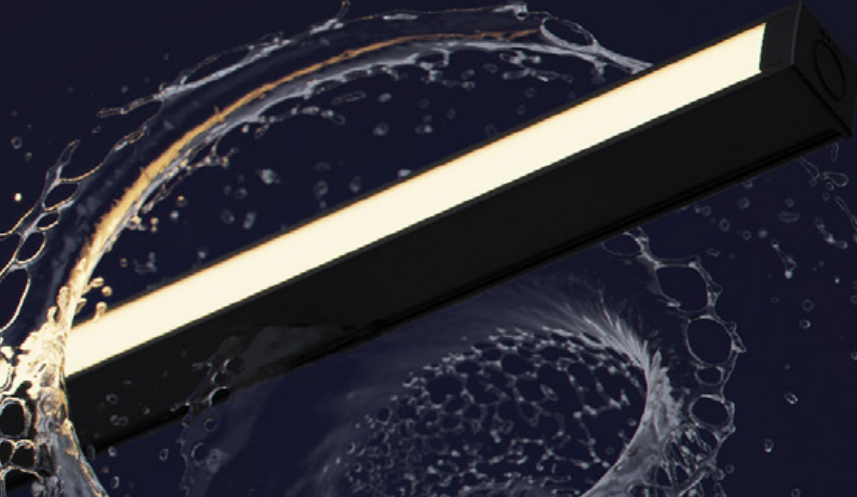

## LONG OPERATING LIFE

Coolon products use the world's most reputable LED manufacturers and the latest available standards to adequately report lumen maintenance. We strive to drive LEDs under their nominal current and use state-of-the-art heat dissipation methods, leading to durable electronics.



## VARIOUS CCT & COLOUR BINNING CONSISTENCY

All products are offered in various colour temperatures, and manufactured using tighter bins, ensuring excellent consistency and uniformity.



## 5 YEARS WARRANTY

Coolon luminaires are covered by a solid comprehensive manufacturer's warranty that covers a range of possible defects and performance parameters throughout the duration of the warranty period.







## PROUDLY MADE IN AUSTRALIA

Our products are designed and manufactured in Australia. Engineered to perfection, using only the highest quality components and highly skilled labour, each luminaire is assembled and thoroughly tested to ensure that it exceeds the highest standards.

■ TECHNICAL SPECIFICATIONS

	9W	16W
Product Code	STR-MULTO IP	
Description	Multo IP LED Strip	
Segment Length (S)	300mm	
Sub-Segment Length (A)	37.5mm	
Number of Sub-Segments	8	
Segment Width	10.50mm	
LED Pitch	6.25mm	
LEDs Per Segment	48	
LEDs Per Sub Segment	6	
Operating Voltage	24VDC	24VDC
Typical Power Consumption per Segment	2.8W	4.8W
Typical Power Consumption per Metre	9.6W/m	16W/m
Typical Current per Segment	120mA	200mA
Colour Rendering Index (CRI)	80+	
Dimmable	Through DRV-DALIPOINT-1X5A, DRV-DALIPOINT-1X10A-IP, or DRV-DIMMERPOINT-1X10A (sold separately)	
Effective Beam Angle	120°	
External Heatsink Required	No	
Ambient Operating Temp	Ta -40°C to 40°C	
Thermal Management	No	
Average Lumen Maintenance @Ta 25°C	70% @ 50,000 Hours	
IP Rating	IP66	
IK Rating	IK08	
Max Continuous Connection Length	Please refer to installation limitations	

■ LUMEN / METRE MATRIX

POWER	LUMINOUS FLUX			
	2700K	3000K	3200K	4000K
<b>9W</b> 9.6W / metre	2700K	3000K	3200K	4000K
<b>P20T</b> Profile (White) 	450 lm / metre	466 lm / metre	466 lm / metre	468 lm / metre
<b>P20T</b> Profile (Black) 	180 lm / metre	196 lm / metre	196 lm / metre	198 lm / metre
<b>16W</b> 16W / metre	2700K	3000K	3200K	4000K
<b>P20T</b> Profile (White) 	800 lm / metre	832 lm / metre	832 lm / metre	880 lm / metre
<b>P20T</b> Profile (Black) 	320 lm / metre	352 lm / metre	352 lm / metre	400 lm / metre

✘ : CCT / Profile combination NOT AVAILABLE    NM : Lumen output NOT MEASURED

■ DIMENSIONS

For final strip lengths please refer to the "Product Length" table.

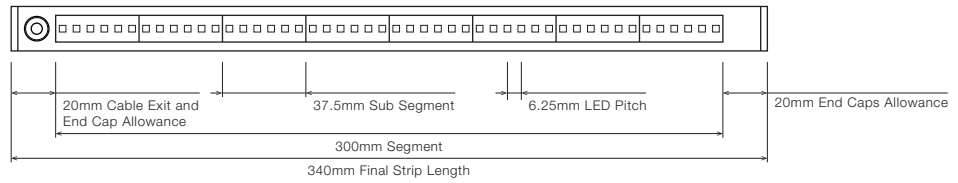

P20T PROFILE

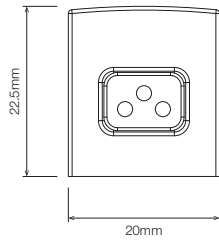

WITH STAINLESS STEEL C-CLIP <sup>1</sup>

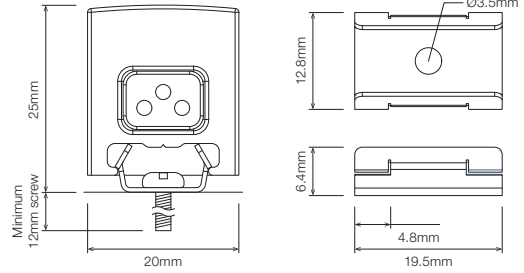

ROTATING MOUNTING BRACKET, TYPE A/B ROTATING CLIP <sup>1</sup>

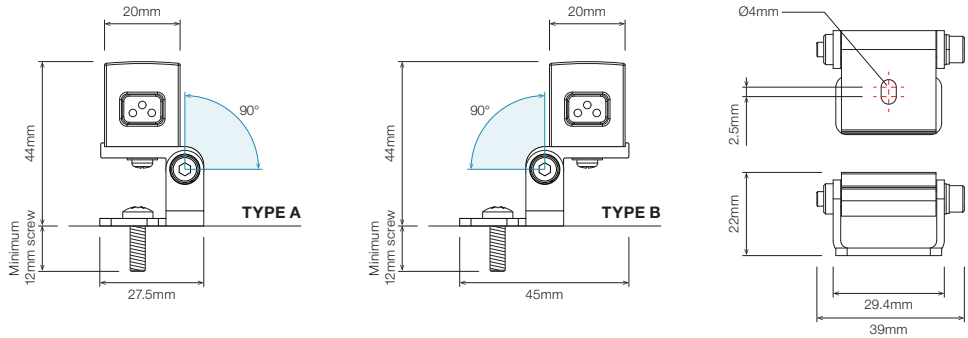

▪ PRODUCT LENGTH WITH P20T

FULL SEGMENTS	SUB SEGMENTS	EXACT STRIP LENGTH	END CAP ALLOWANCE	FINAL LENGTH
PS0	A1	37.5mm	add 40mm	77.5mm
PS0	A2	75mm	add 40mm	115mm
PS0	A3	112.5mm	add 40mm	152.5mm
PS0	A4	150mm	add 40mm	190mm
PS0	A5	187.5mm	add 40mm	227.5mm
PS0	A6	225mm	add 40mm	265mm
PS0	A7	262.5mm	add 40mm	302.5mm
PS1	A0	300mm	add 40mm	340mm
PS1	A1	337.5mm	add 40mm	377.5mm
PS1	A2	375mm	add 40mm	415mm
PS1	A3	412.5mm	add 40mm	452.5mm
PS1	A4	450mm	add 40mm	490mm
PS1	A5	487.5mm	add 40mm	527.5mm
PS1	A6	525mm	add 40mm	565mm
PS1	A7	562.5mm	add 40mm	602.5mm
PS2	A0	600mm	add 40mm	640mm
PS2	A1	637.5mm	add 40mm	677.5mm
PS2	A2	675mm	add 40mm	715mm
PS2	A3	712.5mm	add 40mm	752.5mm
PS2	A4	750mm	add 40mm	790mm
PS2	A5	787.5mm	add 40mm	827.5mm
PS2	A6	825mm	add 40mm	865mm
PS2	A7	862.5mm	add 40mm	902.5mm
PS3	A0	900mm	add 40mm	940mm
PS3	A1	937.5mm	add 40mm	977.5mm
PS3	A2	975mm	add 40mm	1,015mm
PS3	A3	1,012.5mm	add 40mm	1,052.5mm
PS3	A4	1,050mm	add 40mm	1,090mm
PS3	A5	1,087.5mm	add 40mm	1,127.5mm
PS3	A6	1,125mm	add 40mm	1,165mm
PS3	A7	1,162.5mm	add 40mm	1,202.5mm
PS4	A0	1,200mm	add 40mm	1,240mm
PS4	A1	1,237.5mm	add 40mm	1,277.5mm
PS4	A2	1,275mm	add 40mm	1,315mm
PS4	A3	1,312.5mm	add 40mm	1,352.5mm
PS4	A4	1,350mm	add 40mm	1,390mm
PS4	A5	1,387.5mm	add 40mm	1,427.5mm
PS4	A6	1,425mm	add 40mm	1,465mm
PS4	A7	1,462.5mm	add 40mm	1,502.5mm
PS5	A0	1,500mm	add 40mm	1,540mm
PS5	A1	1,537.5mm	add 40mm	1,577.5mm
PS5	A2	1,575mm	add 40mm	1,615mm
PS5	A3	1,612.5mm	add 40mm	1,652.5mm
PS5	A4	1,650mm	add 40mm	1,690mm
PS5	A5	1,687.5mm	add 40mm	1,727.5mm
PS5	A6	1,725mm	add 40mm	1,765mm
PS5	A7	1,762.5mm	add 40mm	1,802.5mm

➤ Continued on next page

**⚠ WARNING**

Do not bend LED strip when removing from mounting clips.

Gently twist LED Strip to remove from mounting clips.

**⚠ WARNING**

**PLEASE HANDLE LONG LED STRIPS WITH CARE.**

LED Strips must not be bent.

When handling LED Strips, please ensure that they are kept straight.

▪ **PRODUCT LENGTH WITH P20T**  
(CONTINUED)

FULL SEGMENTS	SUB SEGMENTS	EXACT STRIP LENGTH	END CAP ALLOWANCE	FINAL LENGTH
PS6	A0	1,800mm	add 40mm	1,840mm
PS6	A1	1,837.5m	add 40mm	1,877.5mm
PS6	A2	1,875mm	add 40mm	1,915mm
PS6	A3	1,912.5mm	add 40mm	1,952.5mm
PS6	A4	1,950mm	add 40mm	1,990mm
PS6	A5	1,987.5mm	add 40mm	2,027.5mm
PS6	A6	2,025mm	add 40mm	2,065mm
PS6	A7	2,062.5mm	add 40mm	2,102.5mm
PS7	A0	2,100mm	add 40mm	2,140mm
PS7	A1	2,137.5mm	add 40mm	2,177.5mm
PS7	A2	2,175mm	add 40mm	2,215mm
PS7	A3	2,212.5mm	add 40mm	2,252.5mm
PS7	A4	2,250mm	add 40mm	2,290mm
PS7	A5	2,287.5mm	add 40mm	2,327.5mm
PS7	A6	2,325mm	add 40mm	2,365mm
PS7	A7	2,362.5mm	add 40mm	2,402.5mm
PS8	A0	2,400mm	add 40mm	2,440mm
PS8	A1	2,437.5mm	add 40mm	2,477.5mm
PS8	A2	2,475mm	add 40mm	2,515mm
PS8	A3	2,512.5mm	add 40mm	2,552.5mm
PS8	A4	2,550mm	add 40mm	2,590mm
PS8	A5	2,587.5mm	add 40mm	2,627.5mm
PS8	A6	2,625mm	add 40mm	2,665mm
PS8	A7	2,662.5mm	add 40mm	2,702.5mm
PS9	A0	2,700mm	add 40mm	2,740mm
PS9	A1	2,737.5mm	add 40mm	2,777.5mm
PS9	A2	2,775mm	add 40mm	2,815mm
PS9	A3	2,812.5mm	add 40mm	2,852.5mm
PS9	A4	2,850mm	add 40mm	2,890mm
PS9	A5	2,887.5mm	add 40mm	2,927.5mm
PS9	A6	2,925mm	add 40mm	2,965mm

- Confirm interstate courier compliance
- Custom length subject to availability

**⚠ WARNING**

Do not bend LED strip when removing from mounting clips.

Gently twist LED Strip to remove from mounting clips.

**⚠ WARNING**

**PLEASE HANDLE LONG LED STRIPS WITH CARE.**

LED Strips must not be bent.

When handling LED Strips, please ensure that they are kept straight.

▪ PROFILE /  
DIFFUSER

**P20T** - P20 Profile Diffused



▪ PROFILE  
COLOUR

Profile colour applicable to P20 only.

**BLK** - Black (Standard)



**WHT** - White (Standard)



**CST** - Custom Colour †

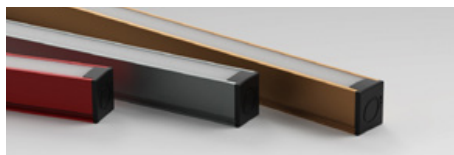

† Custom colours available on request.

▪ WIRING  
CONFIGURATION

CONNECTOR TYPE	DRAWING	MALE	FEMALE
OC2MO Connector 2pin Male Only			
OC2MF Connector 2pin Male + Female			
OC4MO Connector 4pin Male Only			
OC4MF Connector 4pin Male + Female			
SMPLC Sample Type Connector 2.5mm			

▪ For detailed information on Outdoor IP67 connector please contact Coolon.

▪ Please consult Coolon for details on extension cable between LED fittings, drivers and power supplies.

WIRING COLOUR CODE	
Red	+ VDC
Black	GND

▪ IP RATING

**IP66**

Fully protected against dust.  
Protected against wave-like  
water jets from all directions.

▪ P20T Profile



■ INSTALLATION LIMITS

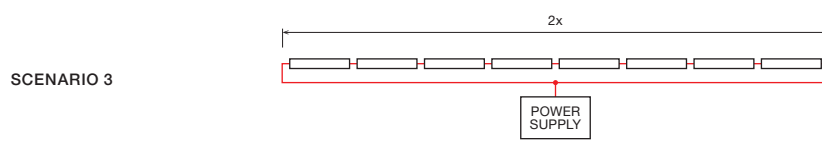
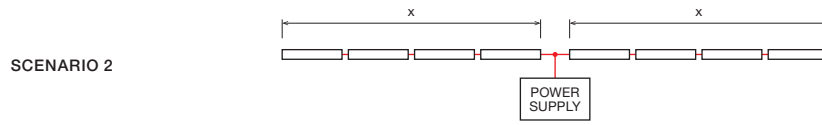
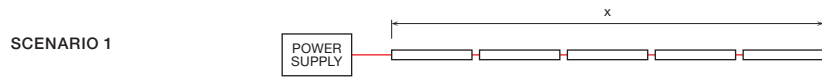

<sup>1</sup> Scenario 4 is the only wiring option available for IP68.

**9W VERSION**

MAX. CONTINUOUS CONNECTION LENGTH (X)	CONNECTOR TYPE
6,900 mm	With outdoor 2 pin connectors (OC2MO / OC2MF)
11,200 mm	With outdoor 4 pin connectors (OC4MO / OC4MF)

▪ Please consult Coolon for details on extension cable between LED fittings, drivers and power supplies.

**16W VERSION**

MAX. CONTINUOUS CONNECTION LENGTH (X)	CONNECTOR TYPE
3,400 mm	With outdoor 2 pin connectors (OC2MO / OC2MF)
5,800 mm	With outdoor 4 pin connectors (OC4MO / OC4MF)

▪ Please consult Coolon for details on extension cable between LED fittings, drivers and power supplies.

**⚠ WARNING**

Avoid connecting multiple power supplies into a single circuit, unless they are specifically designed to do so.

✗

✗

ORDERING EXAMPLE

**STR - MULTO IP - 9W - 3.0K - PS2A0 - P20T - WHT - OC2MO - 100 - IP66**

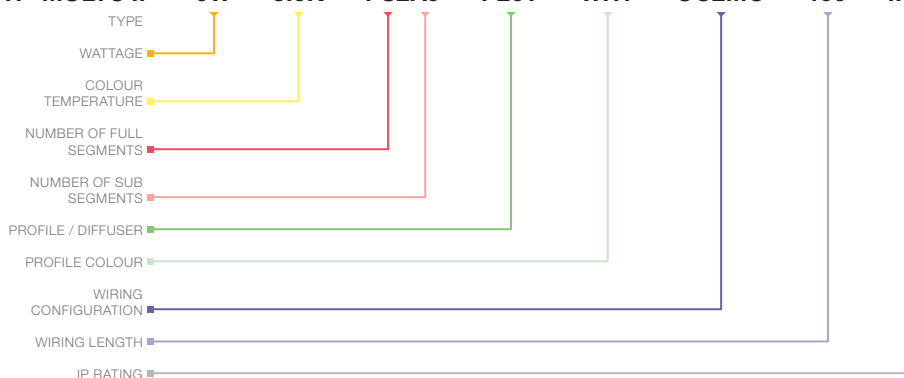

■ **WATTAGE** PAGE 04

9W	9W per Metre
16W	16W per Metre

■ **COLOUR TEMPERATURE** <sup>1</sup> PAGE 05

2.7K	2700K CRI 80
3.0K	3000K CRI 80
3.2K	3200K CRI 80
4.0K	4000K CRI 80

■ **PRODUCT LENGTH** PAGE 07 - 10

FULL SEGMENTS	SUB SEGMENTS
PS0	A0
PS1	A1
PS2	A2
PS3	A3
PS4	A4
PS5	A5
PS6	A6
PS7	A7
PS8	
PS9	

■ **PROFILE / DIFFUSER** PAGE 11

P20T	P20 Profile Diffused
------	----------------------

■ **PROFILE COLOUR** PAGE 11

WHT	White (Standard)
BLK	Black
CST	Custom Colour

■ **WIRING CONFIGURATION** PAGE 12

OC2MO	Connector 2 pin Male Only
OC2MF	Connector 2 pin Male + Female
OC4MO	Connector 4 pin Male Only
OC4MF	Connector 4 pin Male + Female
SMPLC	Sample Type Connector 2.5mm

■ **WIRING LENGTH**





100	100mm
250	250mm
2000	2,000mm

■ **IP RATING** PAGE 12

IP66	Outdoor Use
------	-------------

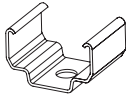
<sup>1</sup> Other CCT subject to availability.

## ■ ACCESSORIES

	PRODUCT CODE	DESCRIPTION
<b>MOUNTING CLIP <sup>1</sup></b>		
	MC-CCLIP20	Stainless Steel C-Clip for P20 Profile
	MBR-RB-TA-P20-BLK	Rotating Bracket, TYPE A Rotating Clip - Black
	MBR-RB-TB-P20-BLK	Rotating Bracket, TYPE B Rotating Clip - Black
<sup>1</sup> Recommended spacing between Mounting Clips and Brackets is maximum 500mm.		
<b>DRIVER</b>		
	DRV-DALIPOINT-1X5A	DALI 5 Amps 1 Channel LED Driver
	DRV-DALIPOINT-IP1X10A	DALI 10 Amps 1 Channel Outdoor LED Driver
	DRV-DIMMERPOINT-1X10A	Rotary Wall-Mount LED Driver
	DRV-RDM-P4	DMX / RDM 4 Channel LED Driver
	DRV-RDM-IP-P4	Outdoor DMX / RDM 4 Channel LED Driver
<b>POWER SUPPLY</b>		
	PWR-HLG-60H-24AU	Mean Well Power Supply HLG 60W 24V IP67
	PWR-HLG-150H-24AU	Mean Well Power Supply HLG 150W 24V IP67
	PWR-HLG-240H-24AU	Mean Well Power Supply HLG 240W 24V IP67
	PWR-HLG-320H-24AU	Mean Well Power Supply HLG 320W 24V IP67
<b>CABLE EXTENSIONS</b>		
	CBLEXT-STR-OC2-IP65-0.6M	0.6m Connector Extension for Strips 1x Red, 1x Black, 0.75mm <sup>2</sup> wires
	CBLEXT-STR-OC2-IP65-3M	3m Connector Extension for Strips 1x Red, 1x Black, 0.75mm <sup>2</sup> wires
	CBLEXT-STR-OC2-IP65-5M	5m Connector Extension for Strips 1x Red, 1x Black, 0.75mm <sup>2</sup> wires