



# SPECTRUM PIXEL IP

LED STRIP STR-SPECTRUM PIXEL IP



Spectrum Pixel IP is a compact and versatile exterior colour changing luminaire with pixel control. The luminaire features dynamic control, with individually addressable 88mm pixels.

The profile is fully encapsulated with polyurethane resin, ensuring superior longevity in outdoor environments. The clear encapsulation option is ideal for indirect lighting applications where the light source is obscured from view, while the translucent version is perfect for direct view applications.

**POWER****PROFILE****10W / METRE****P20T****P20C****RGBW FULL COLOUR**



## RGBW COLOURS

Spectrum Pixel IP offers full gamut RGBW colour ideal for decorative application and dazzling effects.

## ELEGANT ENCAPSULATION

Spectrum Pixel IP utilises Coolon's encapsulation technology to deliver a truly extraordinary outdoor luminaire. IP66, IK08, shock and abrasion resistance, thermal protection, and dashing good looks, all in one.

L70

### LONG USEFUL OPERATING LIFE

Coolon products use the world's most reputable LED manufacturers and the latest available standards to adequately report lumen maintenance. We strive to drive LEDs under their nominal current and use state-of-the-art heat dissipation methods, leading to durable electronics.



### FLEXIBLE COLOUR MIXING VARIATIONS

Quad-chip LEDs provide spectacular colour mixing. Our high performance and superior quality LEDs have the ability to produce 16.7 million colours.

5  
YEARS

### 5 YEARS WARRANTY

Coolon luminaires are covered by a solid comprehensive manufacturer's warranty that covers a range of possible defects and performance parameters throughout the duration of the warranty period.



### PROUDLY MADE IN AUSTRALIA

Our products are designed and manufactured in Australia. Engineered to perfection, using only the highest quality components and highly skilled labour, each luminaire is assembled and thoroughly tested to ensure that it exceeds the highest standards.

TECHNICAL SPECIFICATIONS

Product Code	STR-SPECTRUM PIXEL IP			
Description	Spectrum Pixel IP LED Strip			
Body	Aluminium Alloy Body			
Finish	Powder Coated White (Standard), Various Colours Available			
Cover	Polyurethane			
End Caps	Polycarbonate			
Sub-Segment Length (PIXEL)	88mm			
LED Pitch	14.66mm			
LEDs Per Sub Segment	6			
Operating Voltage	24VDC Nominal, 21VDC absolute minimum (See Lumen Output Impact from Voltage Drop section)			
Typical Power Consumption per Sub-Segment	0.88W			
Typical Power Consumption	10W per Metre			
Typical LED Current	■ Red - 17mA	■ Green - 17mA	■ Blue - 17mA	□ White - 17mA
Colour Rendering Index (CRI)	85 (Static White Only)			
Control	DMX Through CTR-RDM PIXEL NEO			
Effective Beam Angle	116° for P20T, 67° for P20C			
External Heatsink Required	No			
Ambient Operating Temp	Ta -40°C to 50°C			
Average Lumen Maintenance @Ta 25°C	>70% @ 50,000 Hours			
IP Rating	IP66			
IK Rating	IK08			
	▪ Cable exit / entry not part of the IK Rating test			
Typical Wavelength or Colour Temperature CCT	■ Red - 624nm	■ Green - 527nm	■ Blue - 468nm	□ White - 4000K (+/- 200K)

POWER & LUMEN OUTPUT

	POWER / METRE	LUMEN / METRE			
		P20C-WHT	P20T-WHT	P20C-BLK	P20T-BLK
□ White	6W	319 lm per Metre	163 lm per Metre	124 lm per Metre	63 lm per Metre
■ Red	6W	122 lm per Metre	56 lm per Metre	50 lm per Metre	23 lm per Metre
■ Green	6W	268 lm per Metre	117 lm per Metre	103 lm per Metre	45 lm per Metre
■ Blue	6W	67 lm per Metre	25 lm per Metre	29 lm per Metre	11 lm per Metre
■ Yellow	10W	317 lm per Metre	141 lm per Metre	125 lm per Metre	55 lm per Metre
■ Magenta	10W	154 lm per Metre	66 lm per Metre	64 lm per Metre	27 lm per Metre
■ Cyan	10W	269 lm per Metre	117 lm per Metre	106 lm per Metre	45 lm per Metre

LUMEN OUTPUT IMPACT FROM VOLTAGE DROP

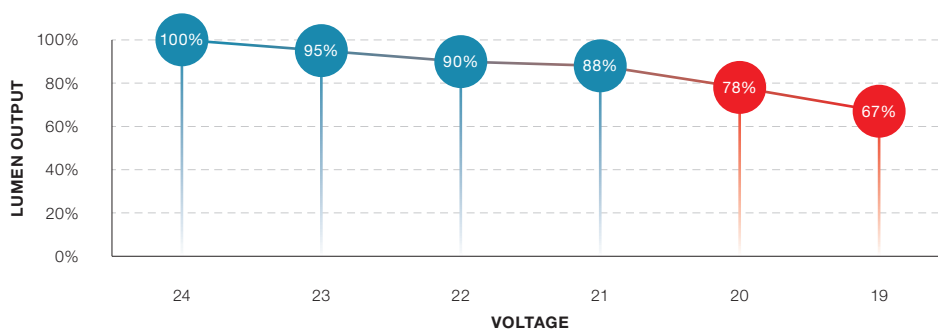

■ DIMENSIONS

For final strip lengths please refer to the "Product Length" table.

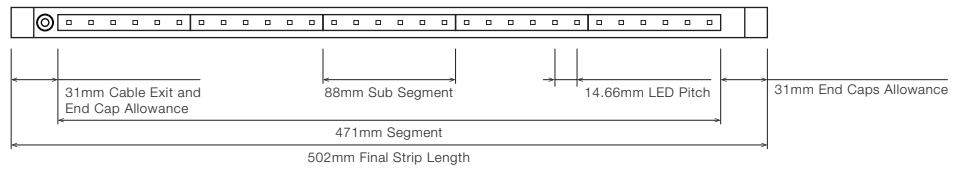

STANDARD PROFILE

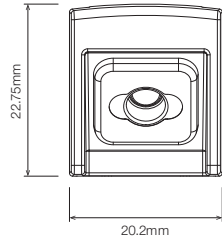

WITH STAINLESS STEEL C-CLIP <sup>1</sup>

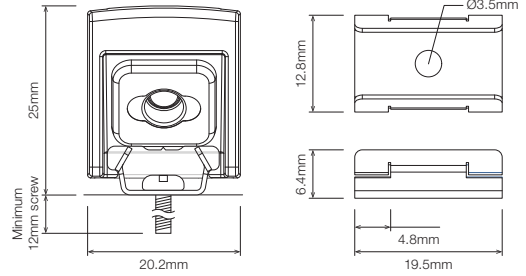

ROTATING MOUNTING BRACKET, TYPE A/B ROTATING CLIP <sup>1</sup>

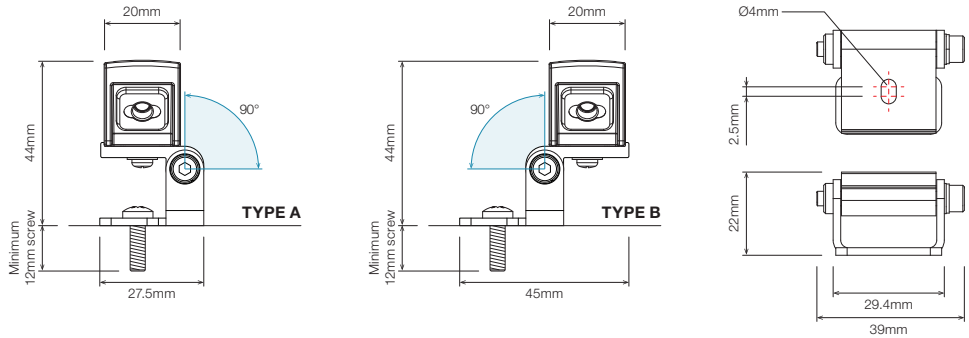

POWER INJECTOR

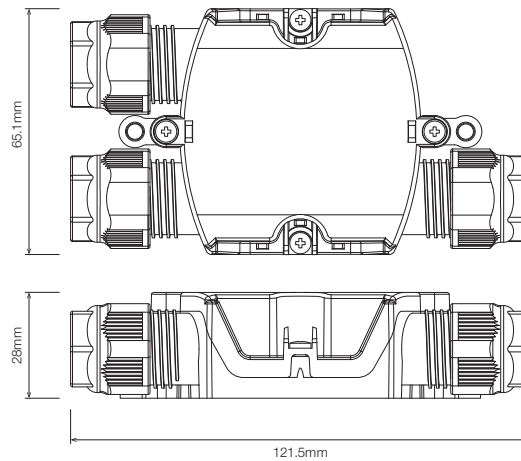

<sup>1</sup> Recommended spacing between Mounting Brackets is maximum 500mm and Mounting Clips is maximum 300mm.



Click on the download icon to view more information regarding mounting and rebate suggestions.

## PRODUCT LENGTH

FULL SEGMENTS	SUB SEGMENTS	EXACT STRIP LENGTH	END CAP ALLOWANCE	FINAL LENGTH
S0	A1	88mm	add 62mm	150mm
S0	A2	176mm	add 62mm	238mm
S0	A3	264mm	add 62mm	326mm
S0	A4	352mm	add 62mm	414mm
S1	A0	440mm	add 62mm	502mm
S1	A1	528mm	add 62mm	590mm
S1	A2	616mm	add 62mm	678mm
S1	A3	704mm	add 62mm	766mm
S1	A4	792mm	add 62mm	854mm
S2	A0	880mm	add 62mm	942mm
S2	A1	968mm	add 62mm	1,030mm
S2	A2	1,056mm	add 62mm	1,118mm
S2	A3	1,144mm	add 62mm	1,206mm
S2	A4	1,232mm	add 62mm	1,294mm
S3	A0	1,320mm	add 62mm	1,382mm
S3	A1	1,408mm	add 62mm	1,470mm
S3	A2	1,496mm	add 62mm	1,558mm
S3	A3	1,584mm	add 62mm	1,646mm
S3	A4	1,672mm	add 62mm	1,734mm
S4	A0	1,760mm	add 62mm	1,822mm
S4	A1	1,848mm	add 62mm	1,910mm
S4	A2	1,936mm	add 62mm	1,998mm
S4	A3	2,024mm	add 62mm	2,086mm
S4	A4	2,112mm	add 62mm	2,174mm
S5	A0	2,200mm	add 62mm	2,262mm
S5	A1	2,288mm	add 62mm	2,350mm
S5	A2	2,376mm	add 62mm	2,438mm
S5	A3	2,464mm	add 62mm	2,526mm
S5	A4	2,552mm	add 62mm	2,614mm
S6	A0	2,640mm	add 62mm	2,702mm
S6	A1	2,728mm	add 62mm	2,790mm
S6	A2	2,816mm	add 62mm	2,878mm
S6	A3	2,904mm	add 62mm	2,966mm
S6	A4	2,992mm	add 62mm	3,054mm

Confirm interstate courier compliance

Custom length subject to availability

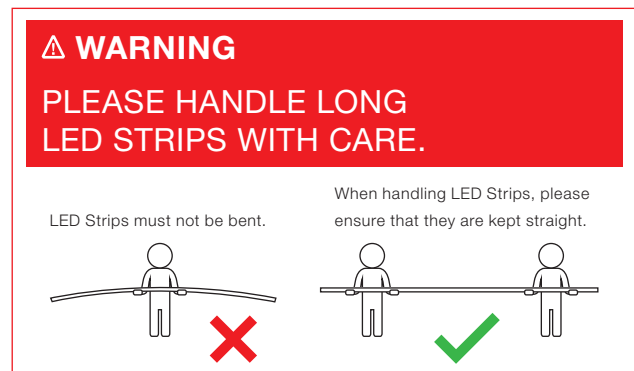
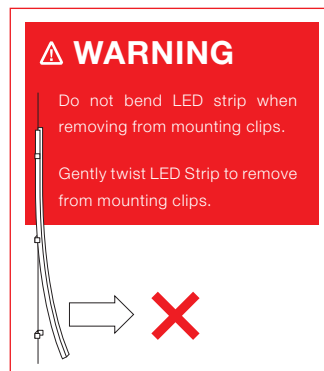

■ PROFILE /  
DIFFUSER

**P20T** · P20 Profile Diffused

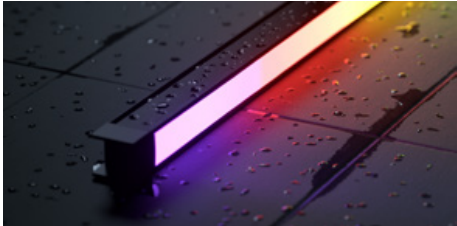

**P20C** · P20 Profile Clear

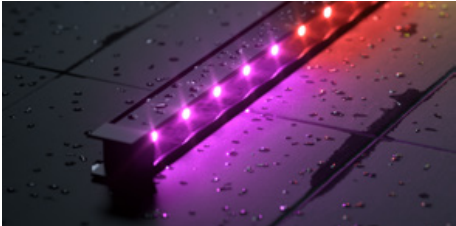

■ PROFILE  
COLOUR

Profile colour applicable to P20 only.

**BLK** · Black



**WHT** · White (Standard)



**CST** · Custom Colour <sup>1</sup>

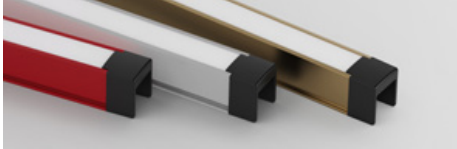

<sup>1</sup> Custom colours available on request.

WIRING CONFIGURATION

CONNECTOR TYPE

DRAWING

MALE IN FEMALE OUT

FC4MF  
Outdoor Connector 4 pin Male + Female



- DATA      ● DATA
- + 24V     ● + 24V
- NC         ● NC
- - GND     ● - GND

• Please consult Coolon for details on extension cables between LED fittings, drivers and PSUs.

WIRING COLOUR CODE	
Brown	Data
Red	Positive / + 24V
Orange	Not Connected
Yellow	Negative / Ground

WIRING POSITION

WA - Adaptable Angled Wiring

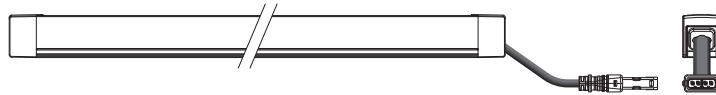

IP RATING

**IP66**

Fully protected against dust.  
Protected against wave-like water jets from all directions.



■ INSTALLATION LIMITS

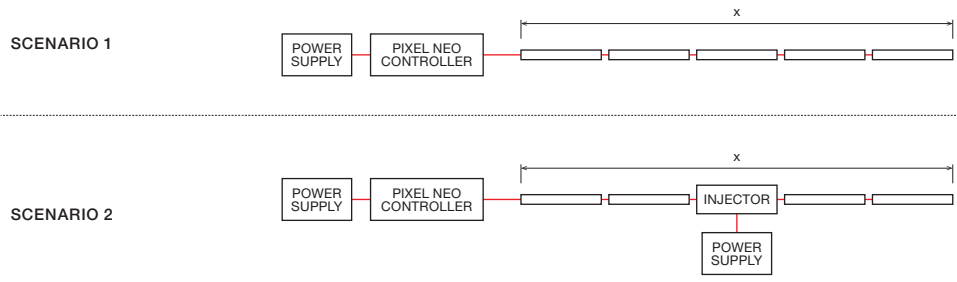

	MAX. CONTINUOUS CONNECTION LENGTH (X)	CONNECTOR TYPE
SCENARIO 1	11,864mm	With standard outdoor 4 pin connectors (FC4MO / FC4MF)
SCENARIO 2	15,227mm	With standard outdoor 4 pin connectors (FC4MO / FC4MF)

- Please consult Coolon for details on extension cables between LED fittings, drivers and PSUs.
- Maximum number of pixels is 170 per run.  
Please refer to Coolon's CTR-RDM PIXEL NEO controller's documentation.

**⚠ WARNING**

Avoid connecting multiple power supplies into a single circuit, unless they are specifically designed to do so.

✗

✗

WIRING DIAGRAM

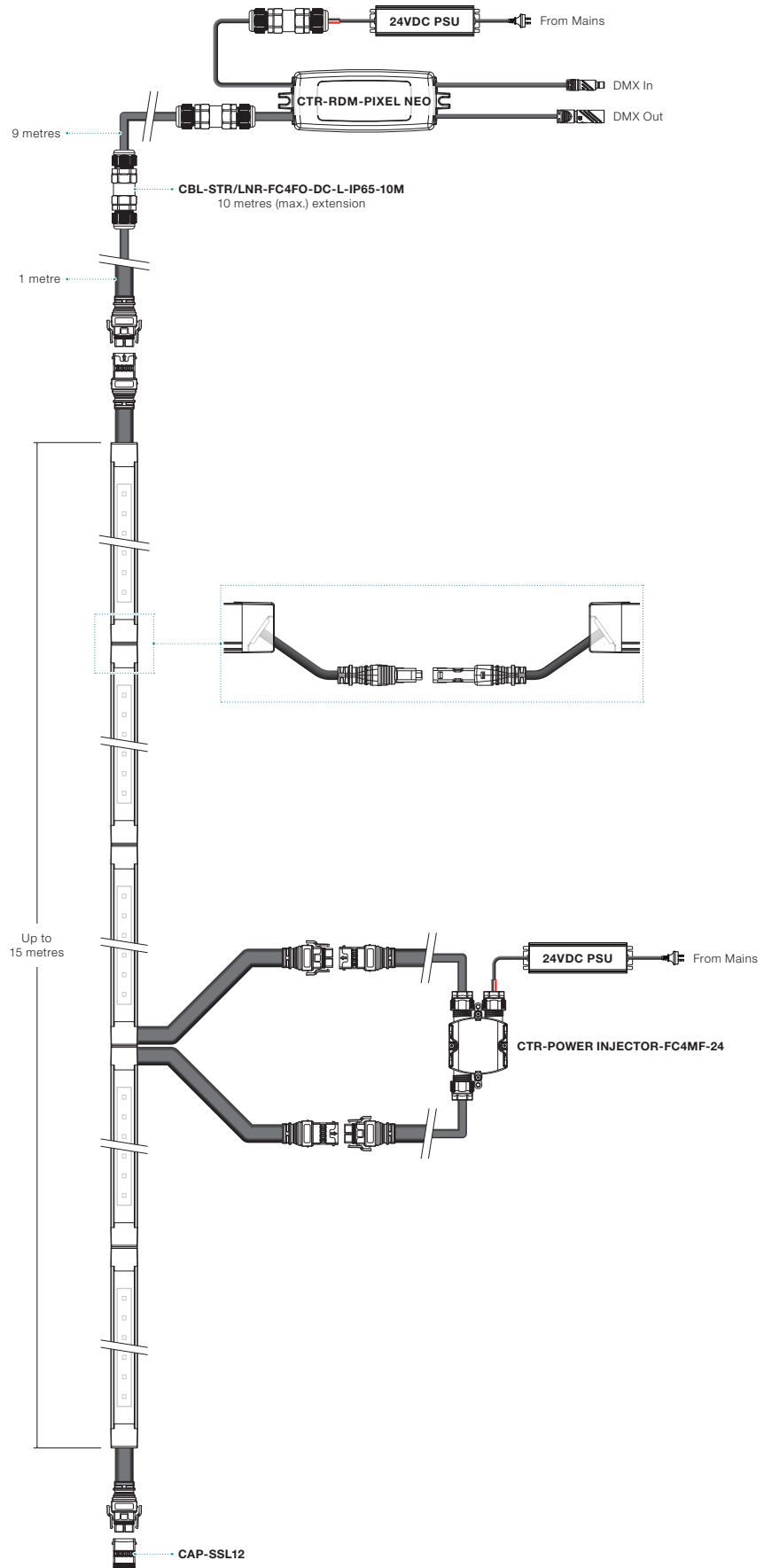

## ORDERING EXAMPLE

### STR - SPECTRUM PIXEL IP - S2A1 - P20T - BLK - FC4MF - WA - 100 - IP66

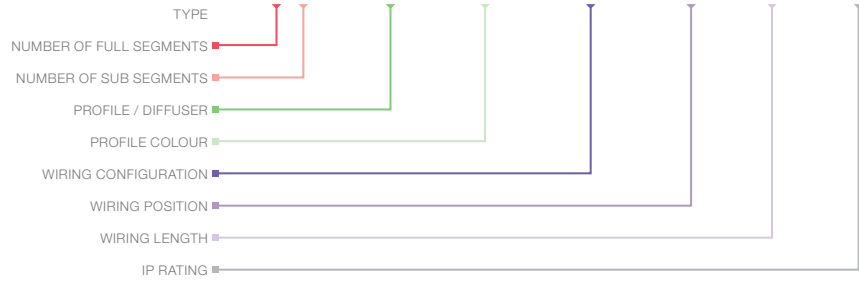

#### PRODUCT LENGTH

FULL SEGMENTS	SUB SEGMENTS
S0	A0
S1	A1
S2	A2
S3	A3
S4	A4
S5	
S6	

#### PROFILE / DIFFUSER

P20T	P20 Profile Translucent Cover
P20C	P20 Profile Clear Cover

#### PROFILE COLOUR <sup>1</sup>

BLK	Black
WHT	White (Standard)
CST	Custom Colour

#### WIRING CONFIGURATION

FC4MF	Outdoor Connector 6 pin Male + Female
-------	---------------------------------------

#### WIRING POSITION

WA	Adaptable Angled
----	------------------

#### WIRING LENGTH



100	100mm
-----	-------

#### IP RATING

IP66	Outdoor Use
------	-------------

<sup>1</sup> Custom colours available on request.

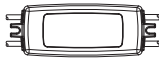
## ■ ACCESSORIES

	PRODUCT CODE	DESCRIPTION
<b>MOUNTING</b>		
	MC-CCLIP20	Stainless Steel C-Clip for P20 Profile
	MBR-RB-TA-BLK	Rotating Bracket, TYPE A Rotating Clip - Black
	MBR-RB-TB-BLK	Rotating Bracket, TYPE B Rotating Clip - Black
<sup>1</sup> Recommended spacing between Mounting Brackets is maximum 500mm and Mounting Clips is maximum 300mm.		
<b>CONTROLLER</b>		
	CTR-RDM PIXEL NEO	Neo Outdoor DMX / RDM to PIXEL Controller
	CTR-POWERINJECTOR-FC4MF-24	Power Injector with Male/Female Flat Cables for 24V PSU
<b>POWER SUPPLY FOR OUTDOOR USE (IP67)</b>		
	PWR-HLG-60H-24AU	Mean Well Power Supply HLG 60W 24V IP67
	PWR-HLG-150H-24AU	Mean Well Power Supply HLG 150W 24V IP67
<b>CABLE EXTENSIONS</b>		
	CBL-STR/LNR-FC4FO-DC-L-IP65-1M	1m Length, Flat Leader Cable with Female Receptacle Outdoor Connector
	CBL-STR/LNR-FC4FO-DC-L-IP65-5M	5m Length, Flat Leader Cable with Female Receptacle Outdoor Connector and 3 Core Cable Lead with Joiner
	CBL-STR/LNR-FC4FO-DC-L-IP65-10M	10m Length, Flat Leader Cable with Female Receptacle Outdoor Connector and 3 Core Cable Lead with Joiner
	CAP-SSL12	Termination CAP for Flat Connectors